



Grand Prix Qingdao 2010

(CHN Qingdao, 17-18 Dec 2010)

-60 kg

19 Judoka

Pool A

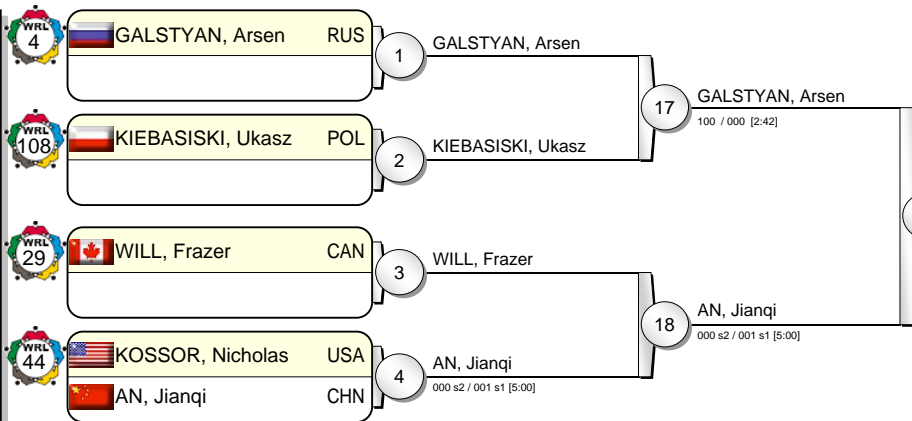

Pool B

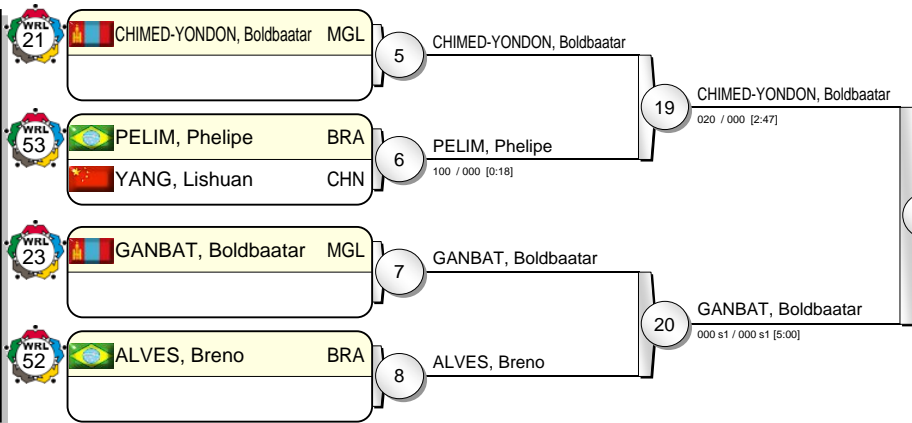

Pool C

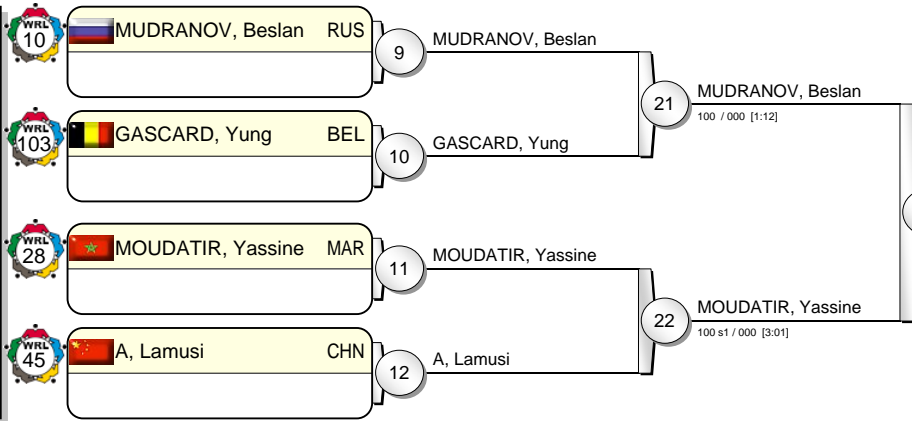

Pool D

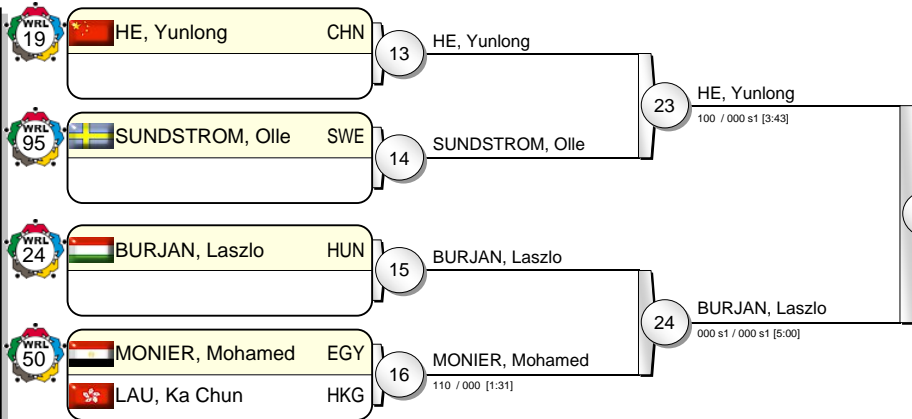

29 GANBAT, Boldbaatar
000 / 100 [5:00]

26 GANBAT, Boldbaatar
000 s2 / 001 s1 [5:00]

GANBAT, Boldbaatar MGL
100 s2 / 001 [4:55] 31

30 MUDRANOV, Beslan
101 / 000 [4:47]

28 HE, Yunlong
100 / 000 [0:27]

Results

- | | | |
|------------------------------|-----|--|
| 1. GANBAT, Boldbaatar | MGL | |
| 2. MUDRANOV, Beslan | RUS | |
| 3. GALSTYAN, Arsen | RUS | |
| 3. HE, Yunlong | CHN | |
| 5. AN, Jianqi | CHN | |
| 5. CHIMED-YONDON, Boldbaatar | MGL | |
| 5. MOUDATIR, Yassine | MAR | |
| 5. BURJAN, Laszlo | HUN | |



Grand Prix Qingdao 2010

(CHN Qingdao, 17-18 Dec 2010)

-66 kg

20 Judoka

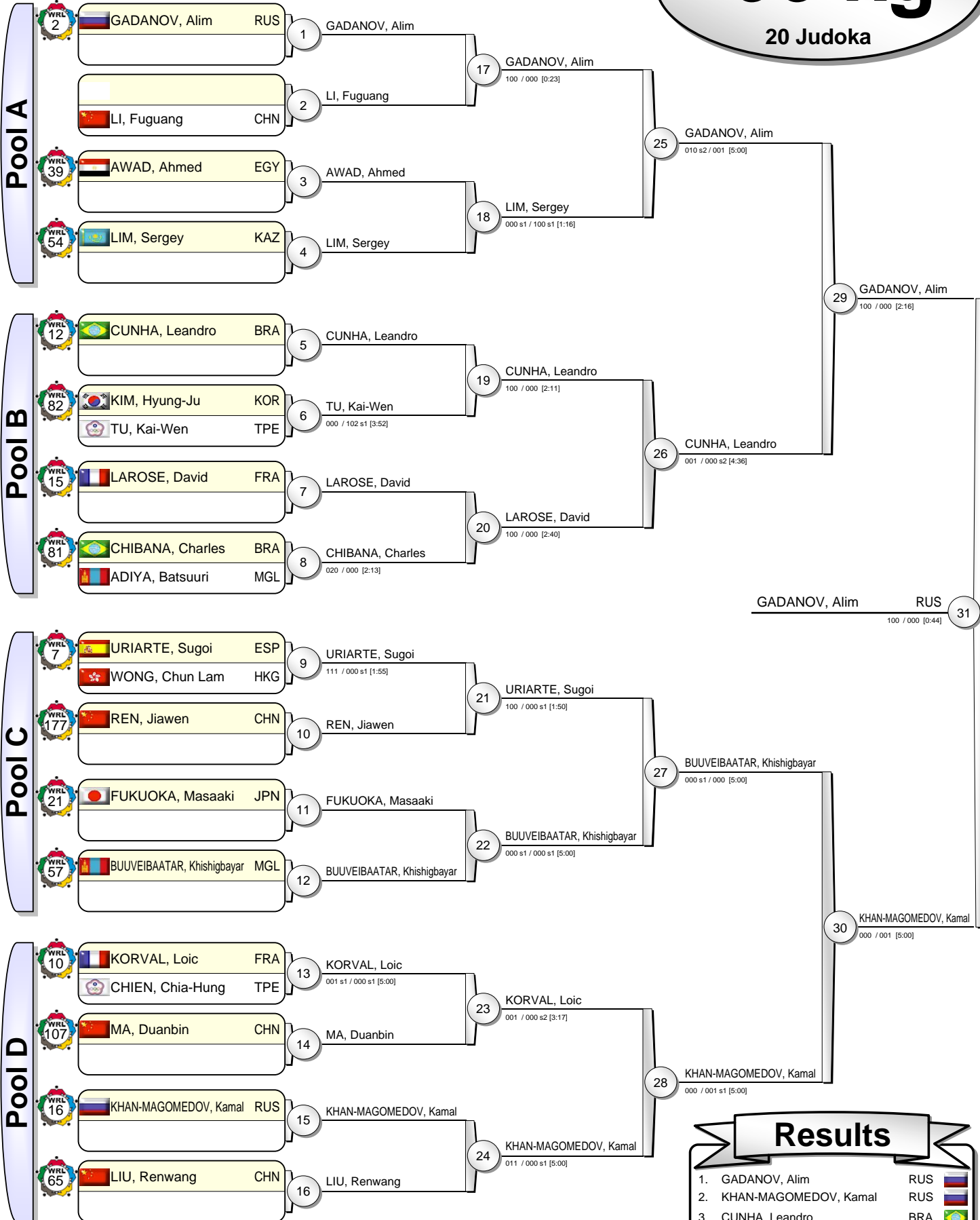

GADANOV, Alim RUS 31
100 / 000 [0:44]

Results

- GADANOV, Alim RUS
- KHAN-MAGOMEDOV, Kamal RUS
- CUNHA, Leandro BRA
- BUUVEIBAATAR, Khishigbayar MGL
- LIM, Sergey KAZ
- LAROSE, David FRA
- URIARTE, Sugoi ESP
- KORVAL, Loic FRA



Grand Prix Qingdao 2010

(CHN Qingdao, 17-18 Dec 2010)

-73 kg

29 Judoka

Pool A

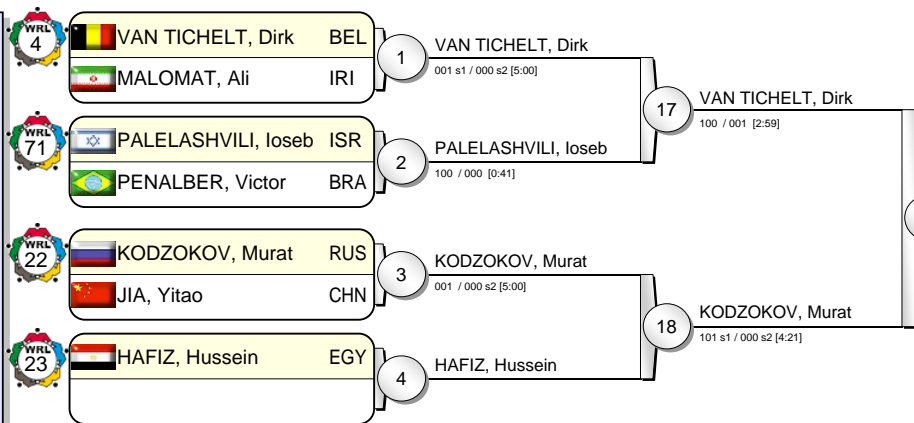

Pool B

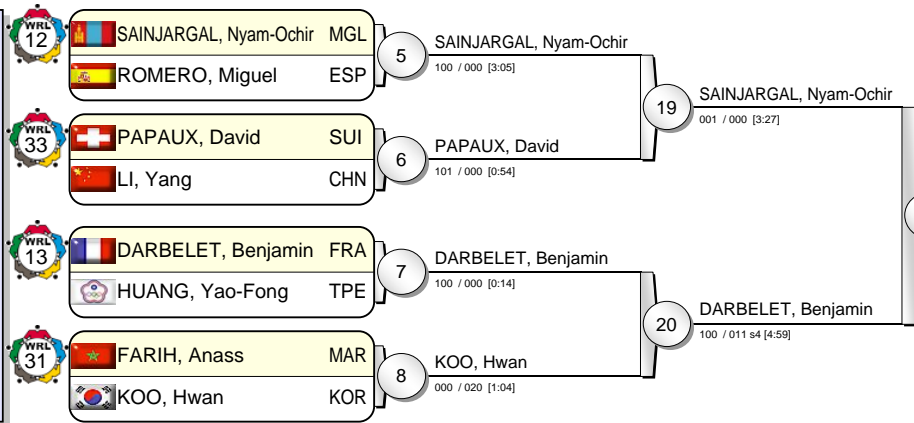

Pool C

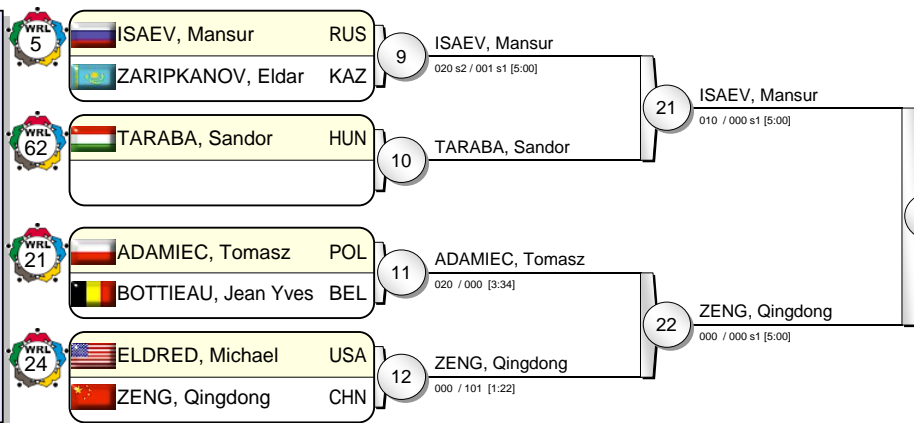

Pool D

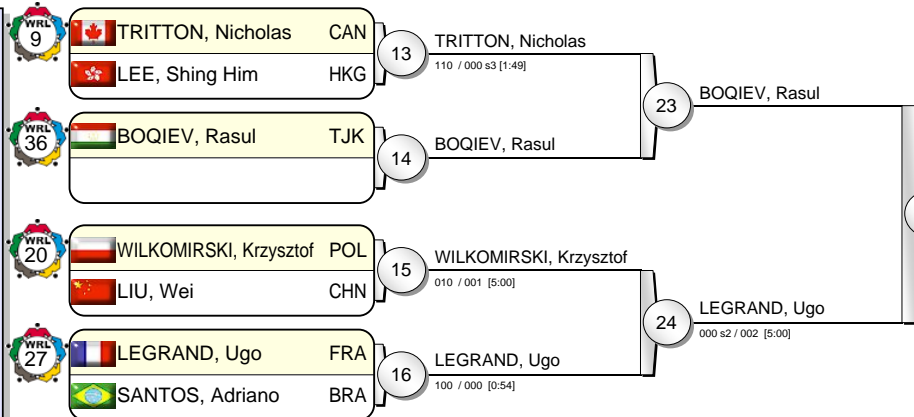

LEGRAND, Ugo FRA 31
000 s1 / 100 s1 [3:51]

Results

- | | | | |
|----|------------------------|-----|--|
| 1. | LEGRAND, Ugo | FRA | |
| 2. | KODZOKOV, Murat | RUS | |
| 3. | DARBELET, Benjamin | FRA | |
| 3. | ISAEV, Mansur | RUS | |
| 5. | VAN TICHELDT, Dirk | BEL | |
| 5. | SAINJARGAL, Nyam-Ochir | MGL | |
| 5. | ZENG, Qingdong | CHN | |
| 5. | BOQIEV, Rasul | TJK | |



Grand Prix Qingdao 2010

(CHN Qingdao, 17-18 Dec 2010)

-81 kg

26 Judoka

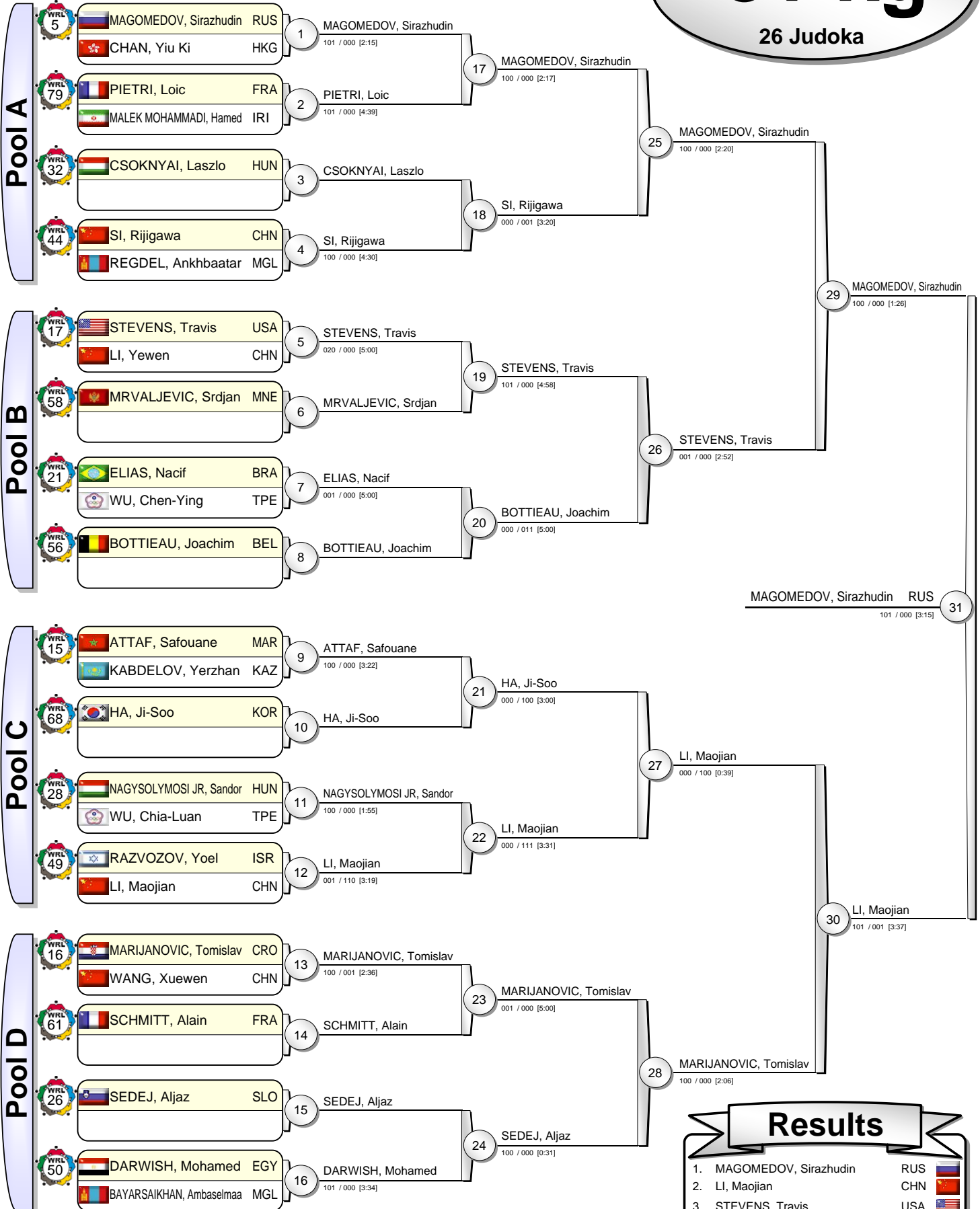

MAGOMEDOV, Sirazhudin RUS 31
101 / 000 [3:15]

Results

- | | | | |
|----|-----------------------|-----|--|
| 1. | MAGOMEDOV, Sirazhudin | RUS | |
| 2. | LI, Maojian | CHN | |
| 3. | STEVENS, Travis | USA | |
| 3. | MARIJANOVIC, Tomislav | CRO | |
| 5. | SI, Rijigawa | CHN | |
| 5. | BOTTIEAU, Joachim | BEL | |
| 5. | HA, Ji-Soo | KOR | |
| 5. | SEDEJ, Aljaz | SLO | |



Grand Prix Qingdao 2010

(CHN Qingdao, 17-18 Dec 2010)

-90 kg

20 Judoka

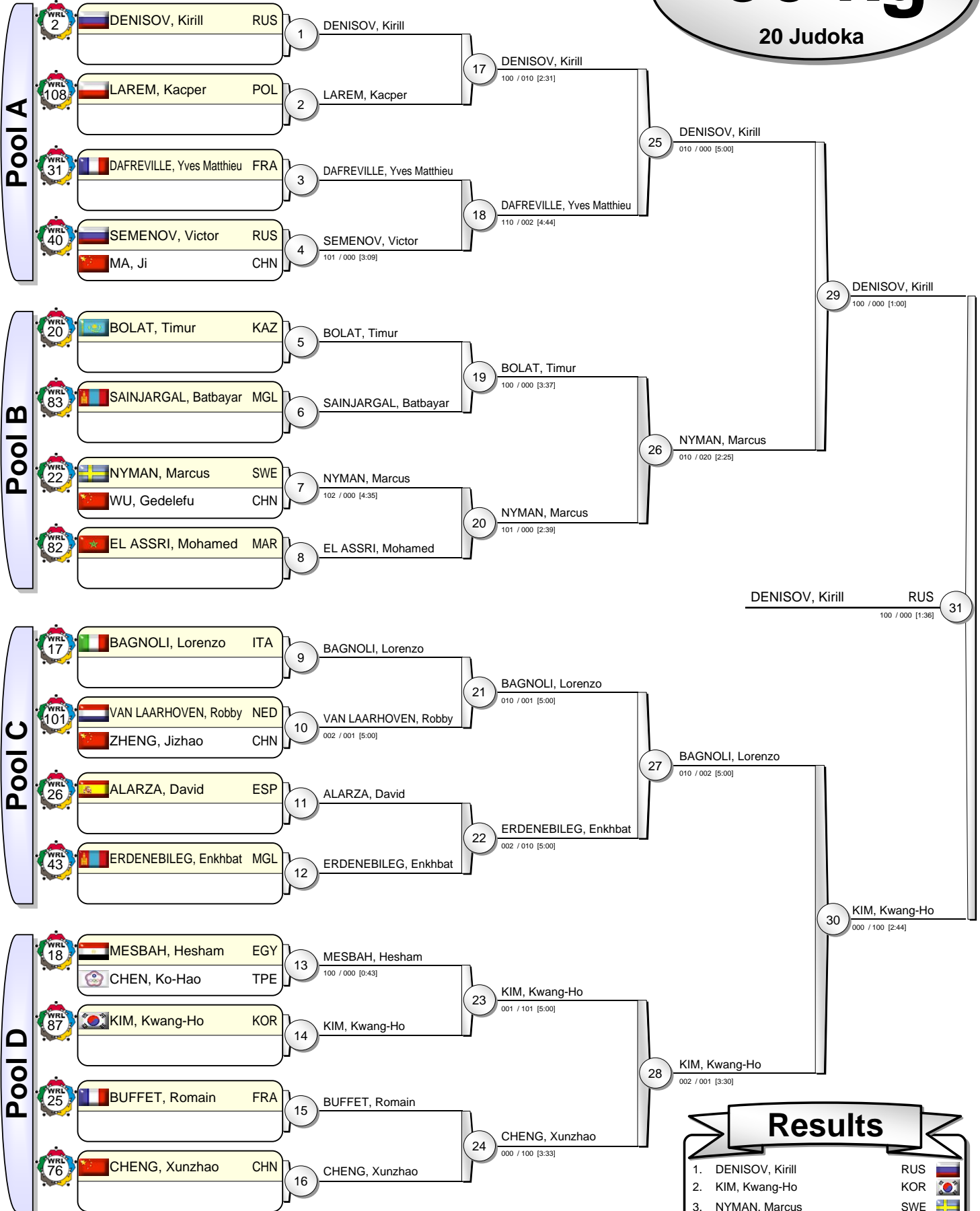

Results

- | | | |
|------------------------------|-----|--|
| 1. DENISOV, Kirill | RUS | |
| 2. KIM, Kwang-Ho | KOR | |
| 3. NYMAN, Marcus | SWE | |
| 3. BAGNOLI, Lorenzo | ITA | |
| 5. DAFREVILLE, Yves Matthieu | FRA | |
| 5. BOLAT, Timur | KAZ | |
| 5. ERDENEBILEG, Enkhbat | MGL | |
| 5. CHENG, Xunzhao | CHN | |



Grand Prix Qingdao 2010

(CHN Qingdao, 17-18 Dec 2010)

-100 kg

14 Judoka

Pool A

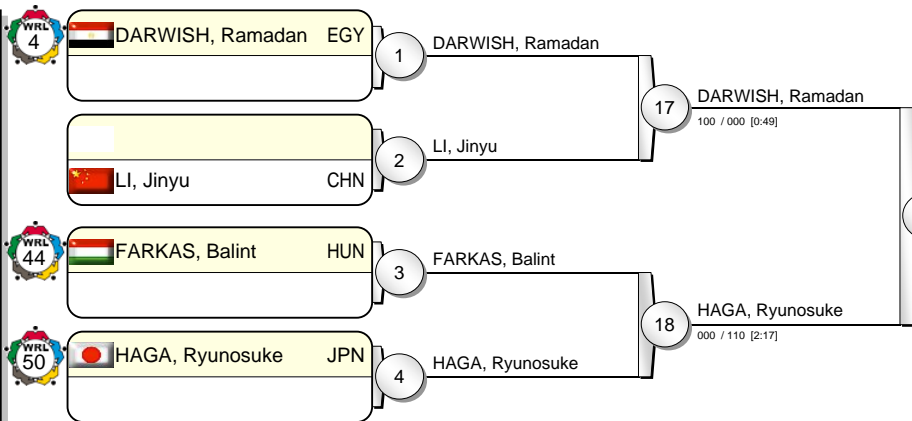

Pool B

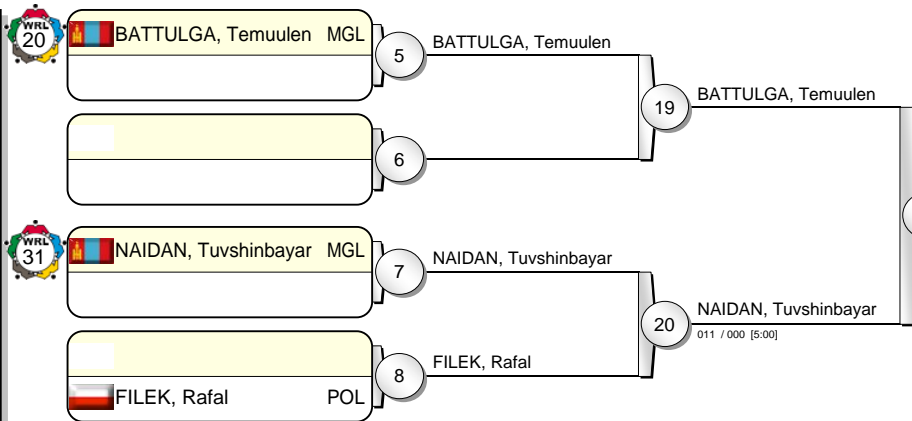

Pool C

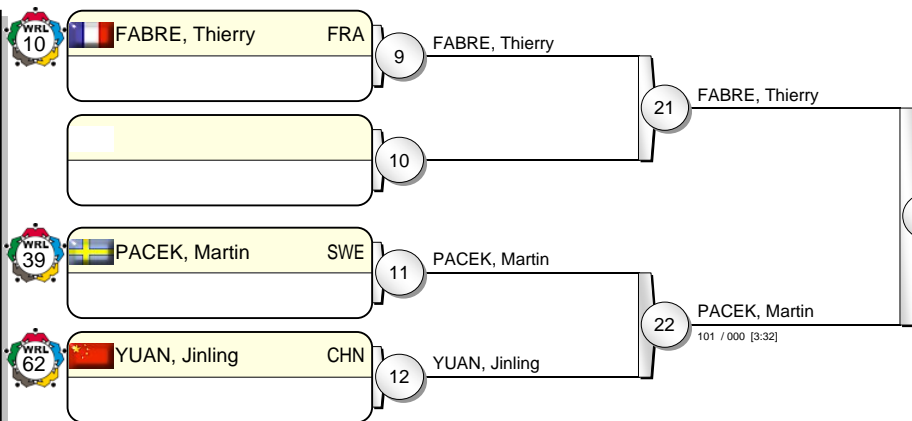

Pool D

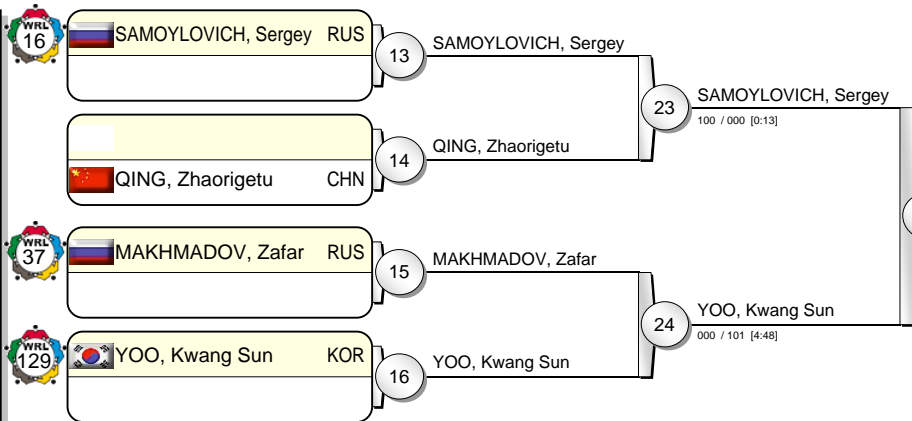

29 BATTULGA, Temuulen [000 / 100 [0:45]]

26 BATTULGA, Temuulen [010 / 001 [5:00]]

31 SAMOYLOVICH, Sergey (RUS) [000 / 020 [4:12]]

30 SAMOYLOVICH, Sergey [000 / 100 [0:20]]

Results

- | | | |
|-------------------------|-----|--|
| 1. SAMOYLOVICH, Sergey | RUS | |
| 2. BATTULGA, Temuulen | MGL | |
| 3. HAGA, Ryunosuke | JPN | |
| 3. PACEK, Martin | SWE | |
| 5. DARWISH, Ramadan | EGY | |
| 5. NAIDAN, Tuvshinbayar | MGL | |
| 5. FABRE, Thierry | FRA | |
| 5. YOO, Kwang Sun | KOR | |



Grand Prix Qingdao 2010

(CHN Qingdao, 17-18 Dec 2010)

+100 kg

14 Judoka

Pool A

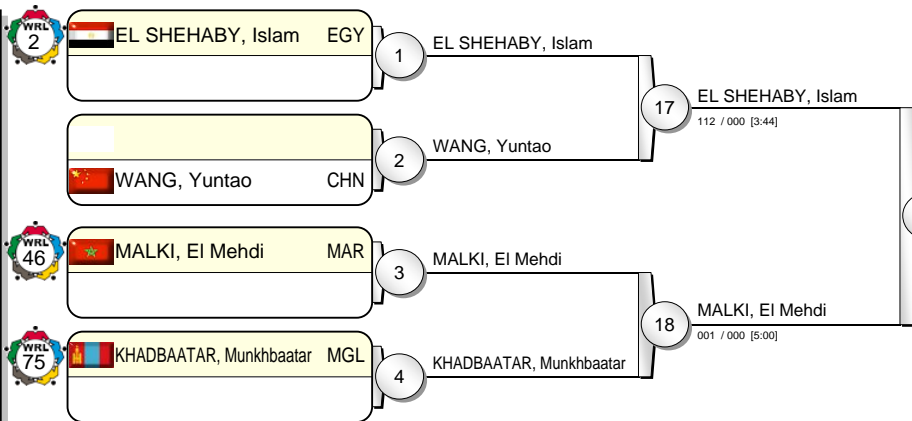

Pool B

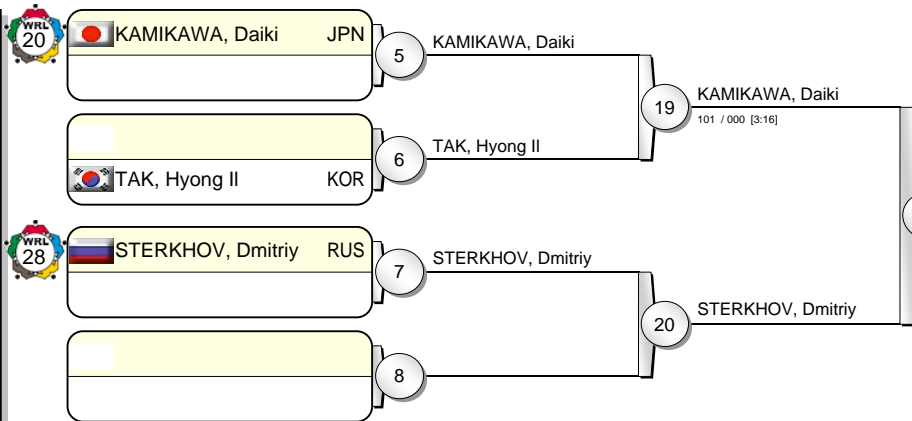

Pool C

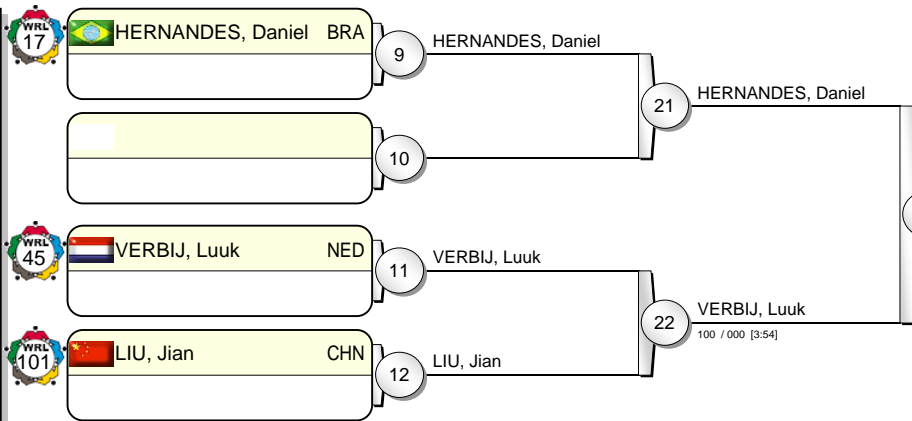

Pool D

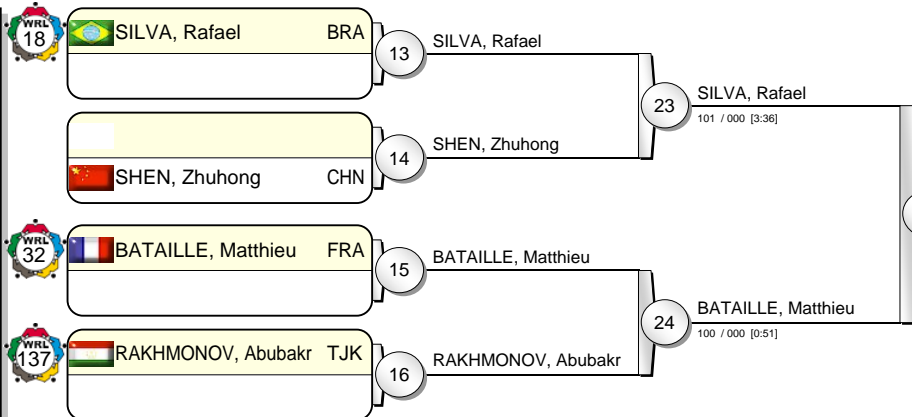

EL SHEHABY, Islam EGY 100 / 000 [0:01] 31

HERNANDES, Daniel 101 / 001 [2:27] 30

Results

| | | | |
|----|--------------------|-----|--|
| 1. | EL SHEHABY, Islam | EGY | |
| 2. | HERNANDES, Daniel | BRA | |
| 3. | STERKHOV, Dmitriy | RUS | |
| 3. | SILVA, Rafael | BRA | |
| 5. | MALKI, El Mehdi | MAR | |
| 5. | KAMIKAWA, Daiki | JPN | |
| 5. | VERBIJ, Luuk | NED | |
| 5. | BATAILLE, Matthieu | FRA | |



Grand Prix Qingdao 2010

(CHN Qingdao, 17-18 Dec 2010)

-48 kg

17 Judoka

Pool A

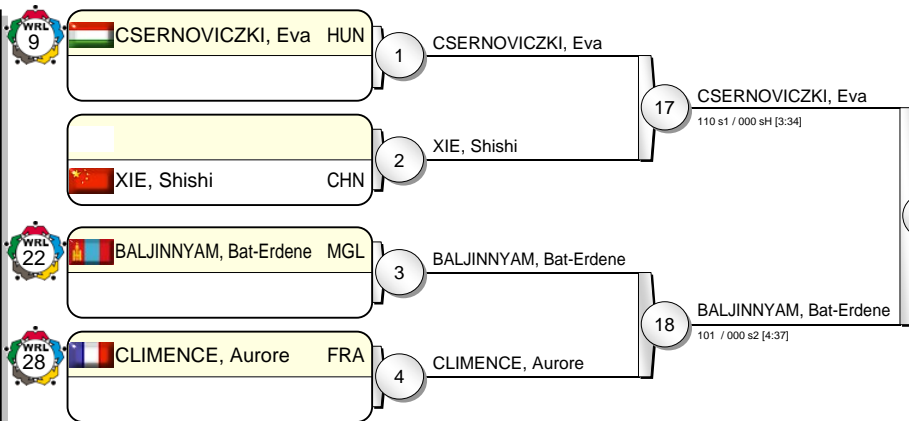

Pool B

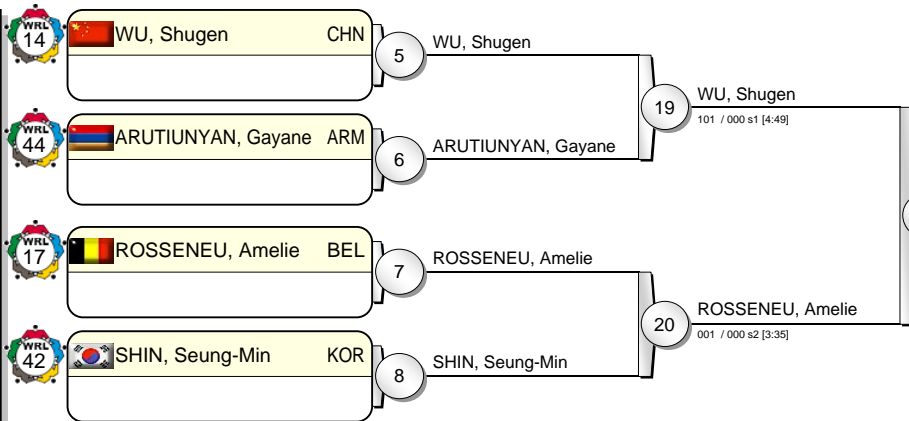

Pool C

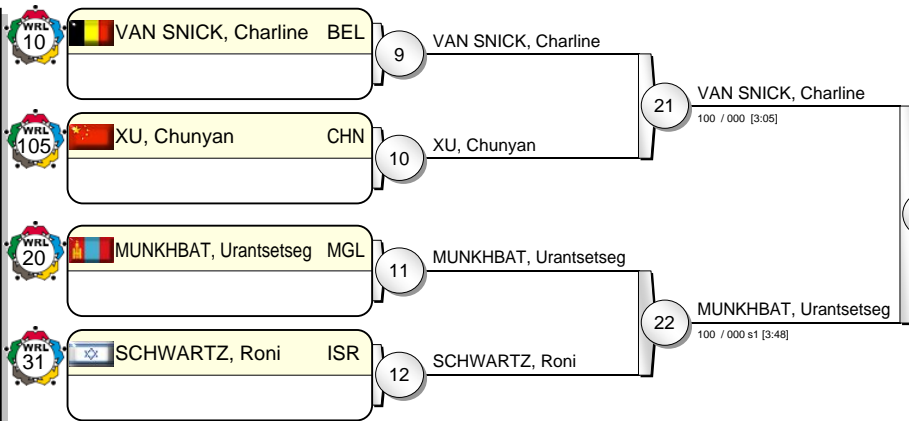

Pool D

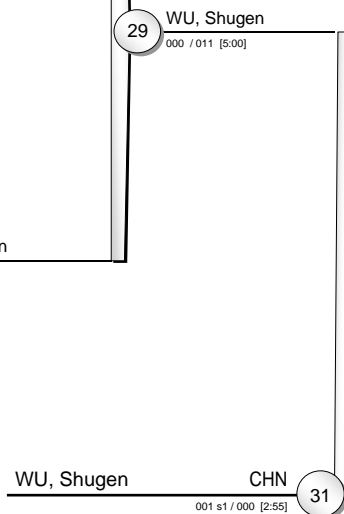
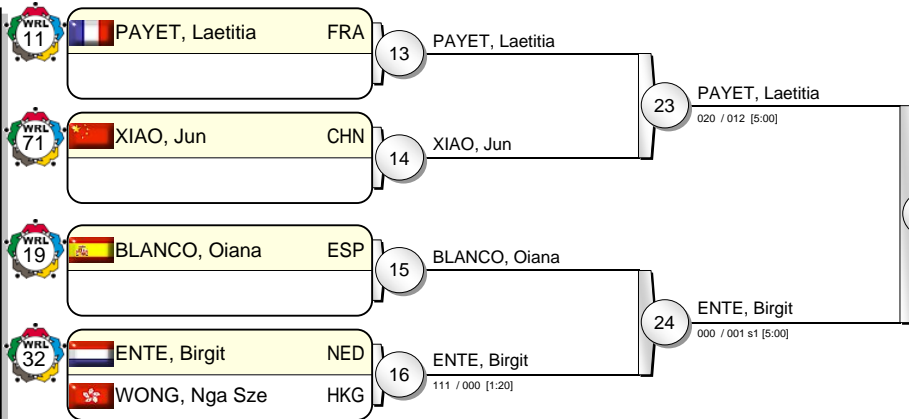

Results

- | | | |
|---------------------------|-----|--|
| 1. WU, Shugen | CHN | |
| 2. PAYET, Laetitia | FRA | |
| 3. BALJINNYAM, Bat-Erdene | MGL | |
| 3. MUNKHBAT, Urantsetseg | MGL | |
| 5. CSERNOVICZKI, Eva | HUN | |
| 5. ROSSENEU, Amelie | BEL | |
| 5. VAN SNICK, Charline | BEL | |
| 5. ENTE, Birgit | NED | |



Grand Prix Qingdao 2010

(CHN Qingdao, 17-18 Dec 2010)

-52 kg

17 Judoka

Pool A

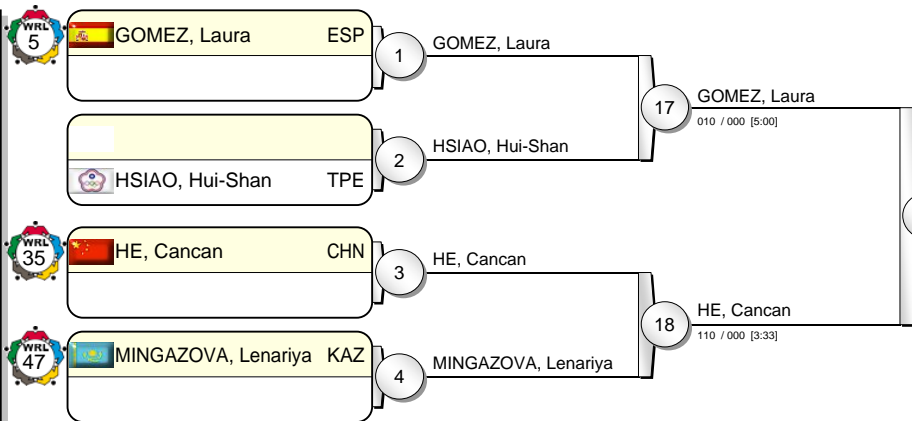

Pool B

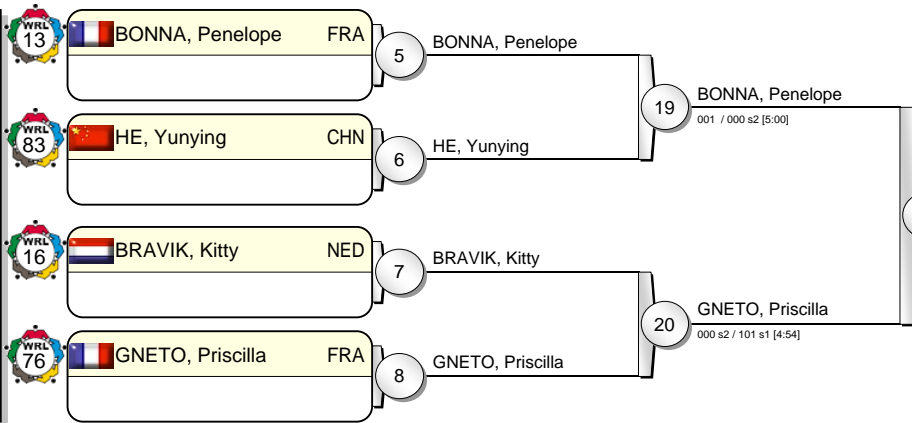

Pool C

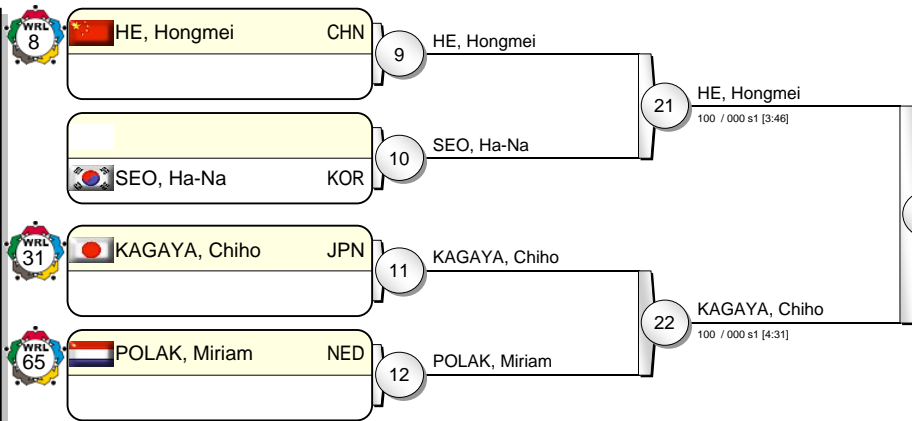

Pool D

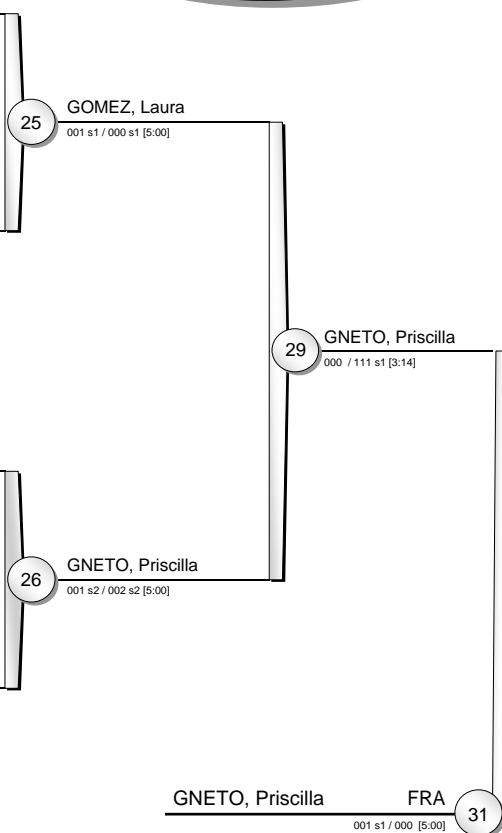
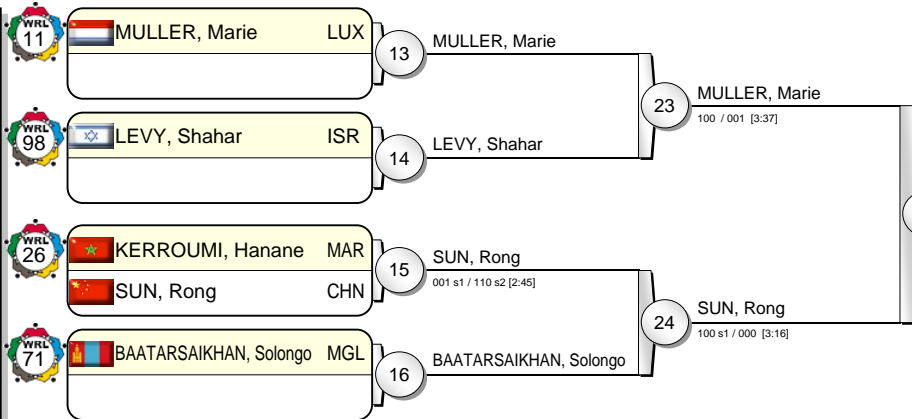

GNETO, Priscilla FRA 31
001 s1 / 000 [5:00]

Results

- | | | | |
|----|------------------|-----|--|
| 1. | GNETO, Priscilla | FRA | |
| 2. | KAGAYA, Chiho | JPN | |
| 3. | GOMEZ, Laura | ESP | |
| 3. | SUN, Rong | CHN | |
| 5. | HE, Cancan | CHN | |
| 5. | BONNA, Penelope | FRA | |
| 5. | HE, Hongmei | CHN | |
| 5. | MULLER, Marie | LUX | |



Grand Prix Qingdao 2010

(CHN Qingdao, 17-18 Dec 2010)

-57 kg

19 Judoka

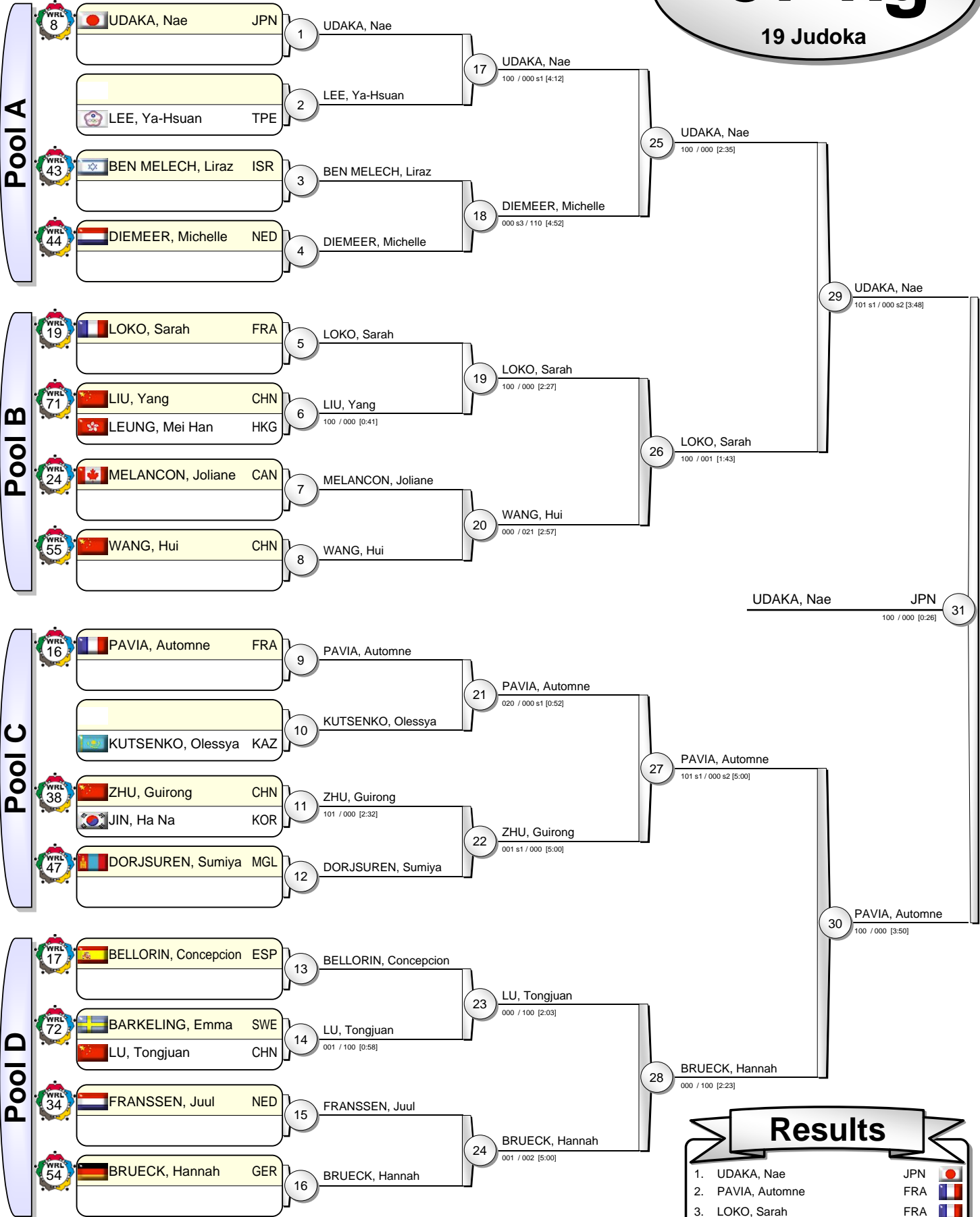

UDAKA, Nae JPN 31
100 / 000 [0:26]

PAVIA, Automne FRA 30
101 s1 / 000 s2 [5:00]

PAVIA, Automne FRA 30
100 / 000 [3:50]

BRUECK, Hannah GER 28
000 / 100 [2:23]

- ### Results
- | | | |
|----------------------|-----|--|
| 1. UDAKA, Nae | JPN | |
| 2. PAVIA, Automne | FRA | |
| 3. LOKO, Sarah | FRA | |
| 3. BRUECK, Hannah | GER | |
| 5. DIEMEER, Michelle | NED | |
| 5. WANG, Hui | CHN | |
| 5. ZHU, Guirong | CHN | |
| 5. LU, Tongjuan | CHN | |



Grand Prix Qingdao 2010

(CHN Qingdao, 17-18 Dec 2010)

-63 kg

13 Judoka

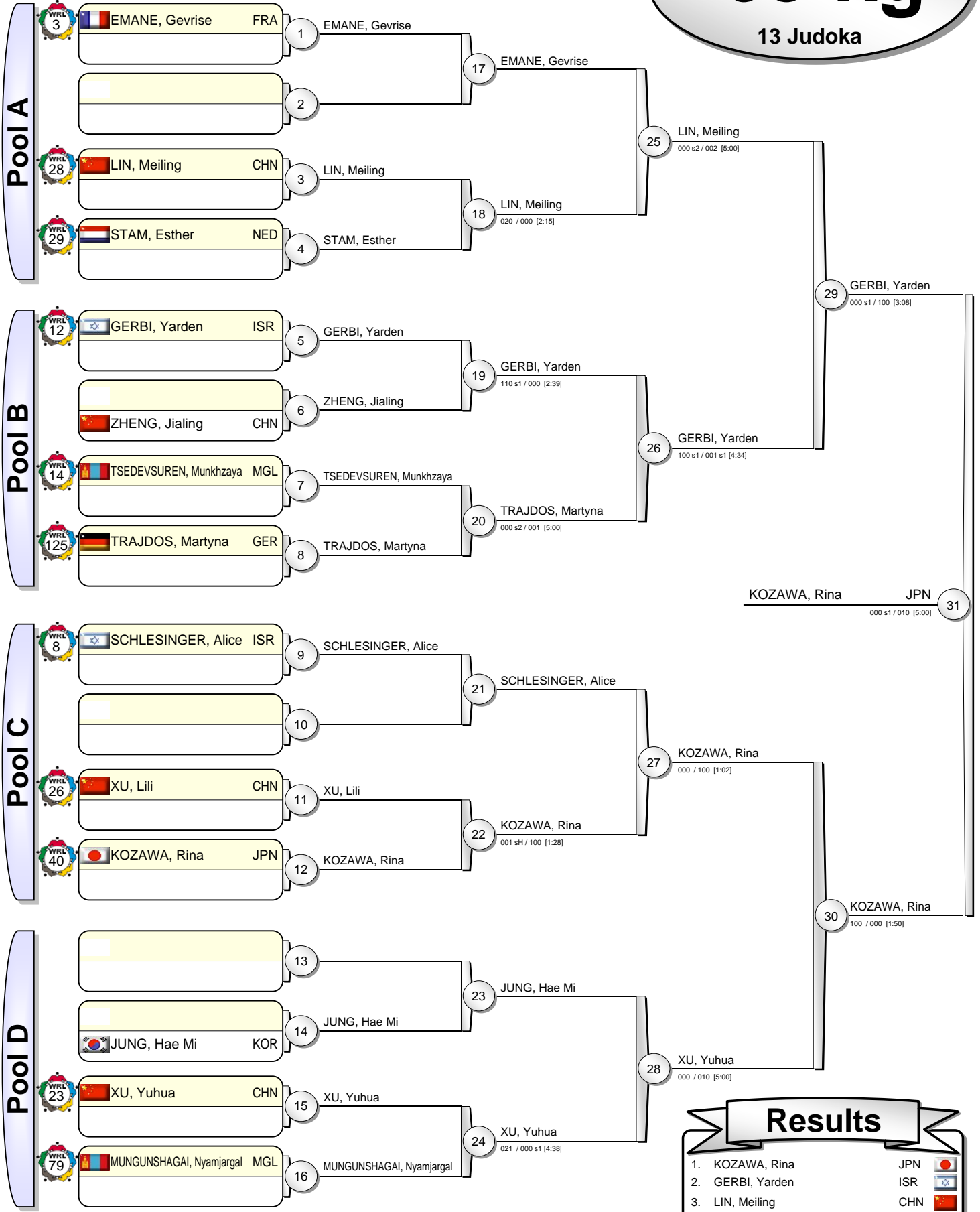

KOZAWA, Rina JPN 31
000 s1 / 010 [5:00]

KOZAWA, Rina 27
000 / 100 [1:02]

30 KOZAWA, Rina
100 / 000 [1:50]

Results

| | | |
|-----------------------|-----|--|
| 1. KOZAWA, Rina | JPN | |
| 2. GERBI, Yarden | ISR | |
| 3. LIN, Meiling | CHN | |
| 3. XU, Yuhua | CHN | |
| 5. EMANE, Gevrise | FRA | |
| 5. TRAJDOS, Martyna | GER | |
| 5. SCHLESINGER, Alice | ISR | |
| 5. JUNG, Hae Mi | KOR | |



Grand Prix Qingdao 2010

(CHN Qingdao, 17-18 Dec 2010)

-70 kg

15 Judoka

Pool A

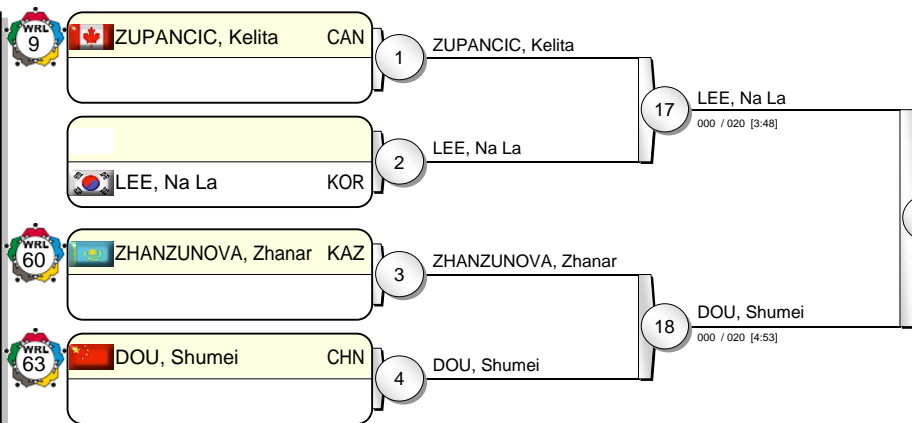

Pool B

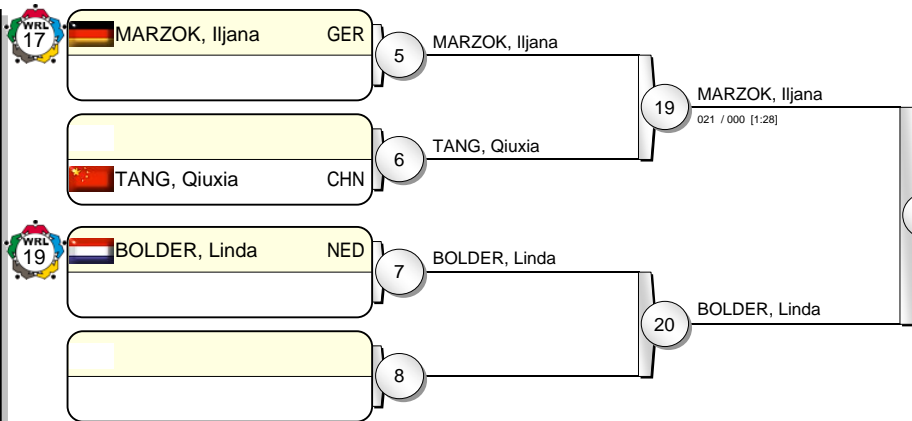

Pool C

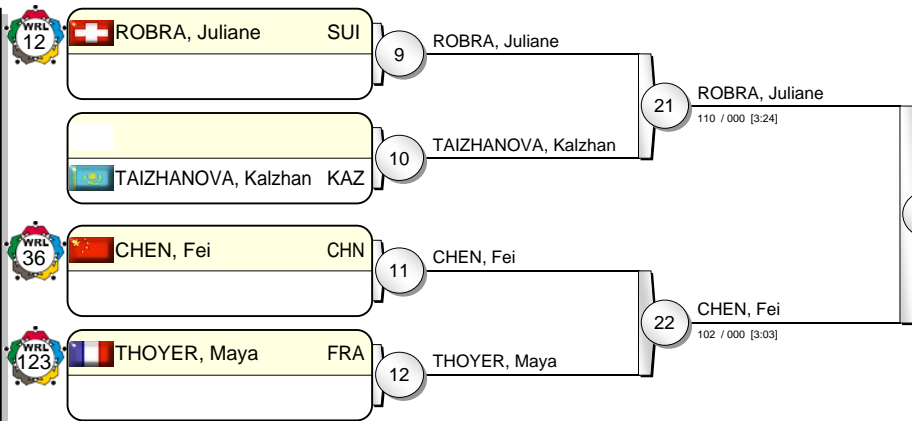

Pool D

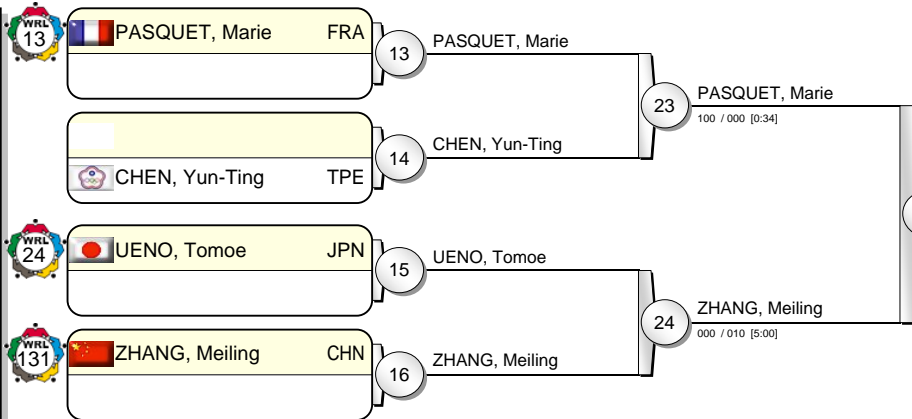

BOLDER, Linda NED 001 / 000 [3:18] 31

CHEN, Fei 010 / 000 [2:18] 30

Results

- | | | |
|-------------------|-----|--|
| 1. BOLDER, Linda | NED | |
| 2. CHEN, Fei | CHN | |
| 3. LEE, Na La | KOR | |
| 3. PASQUET, Marie | FRA | |
| 5. DOU, Shumei | CHN | |
| 5. MARZOK, Iljana | GER | |
| 5. ROBRA, Juliane | SUI | |
| 5. ZHANG, Meiling | CHN | |



Grand Prix Qingdao 2010

(CHN Qingdao, 17-18 Dec 2010)

-78 kg

15 Judoka

Pool A

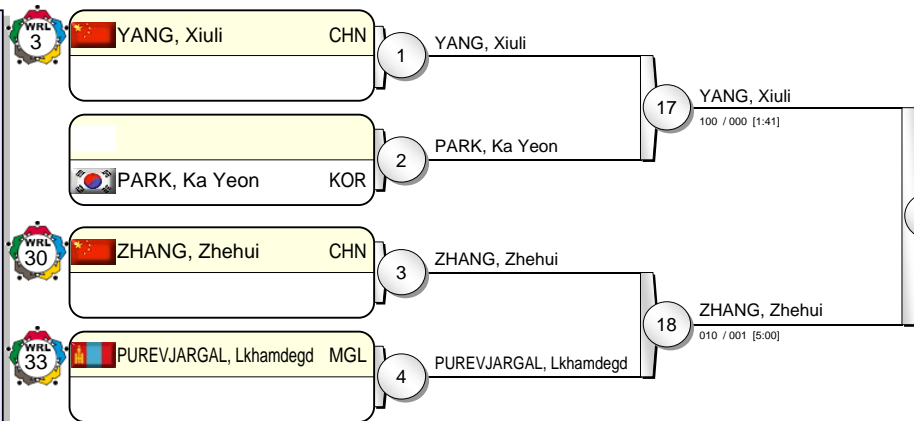

Pool B

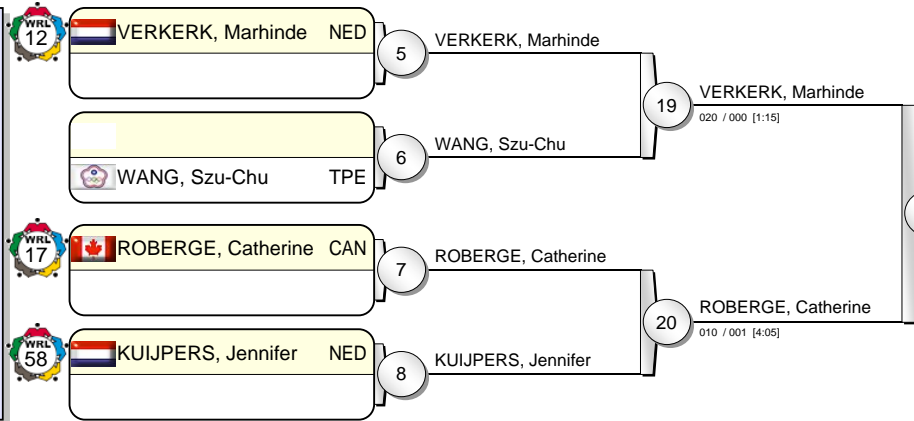

Pool C

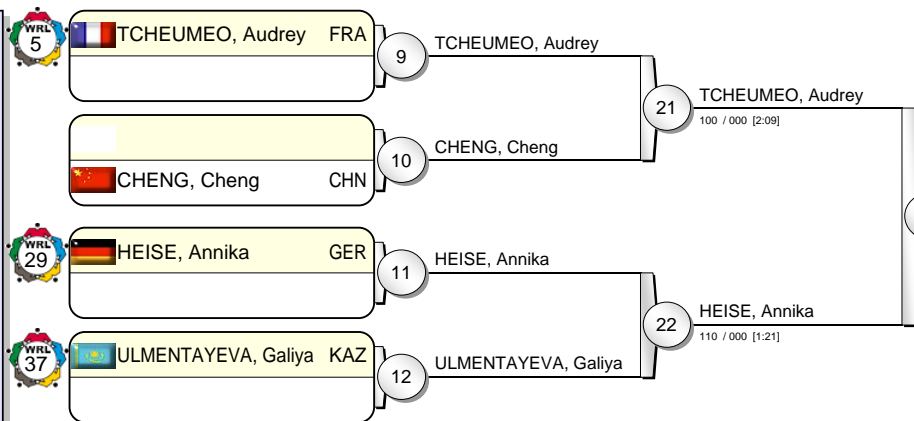

Pool D

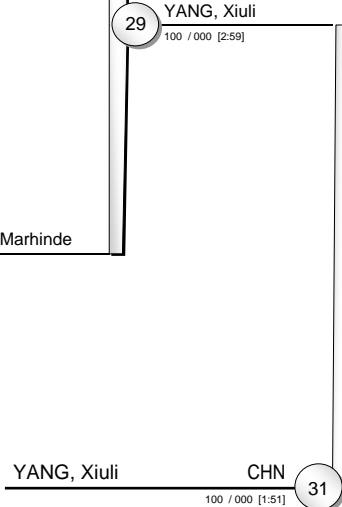
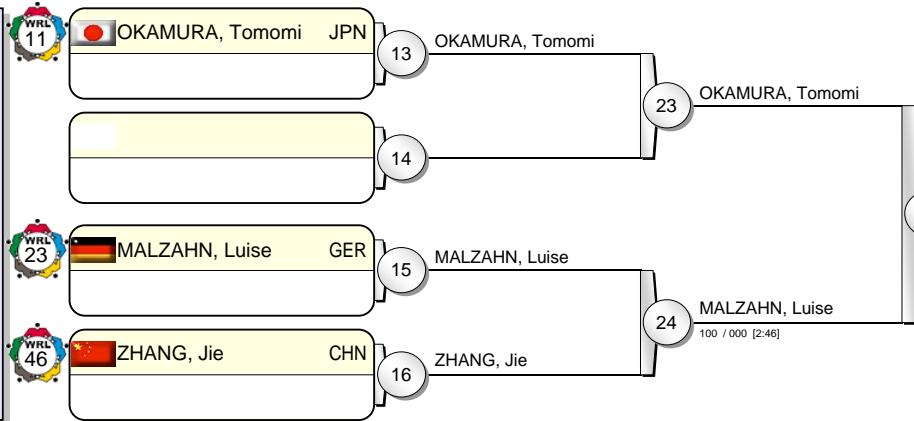

YANG, Xiuli CHN 31
100 / 000 [1:51]

Results

- | | | |
|-----------------------|-----|--|
| 1. YANG, Xiuli | CHN | |
| 2. OKAMURA, Tomomi | JPN | |
| 3. VERKERK, Marhinde | NED | |
| 3. HEISE, Annika | GER | |
| 5. ZHANG, Zhehui | CHN | |
| 5. ROBERGE, Catherine | CAN | |
| 5. TCHEUMEO, Audrey | FRA | |
| 5. MALZAHN, Luise | GER | |



Grand Prix Qingdao 2010

(CHN Qingdao, 17-18 Dec 2010)

+78 kg

7 Judoka

Pool A

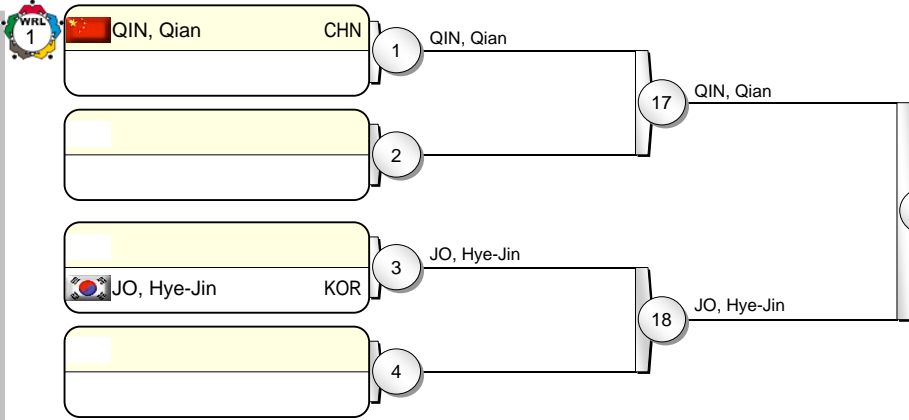

Pool B

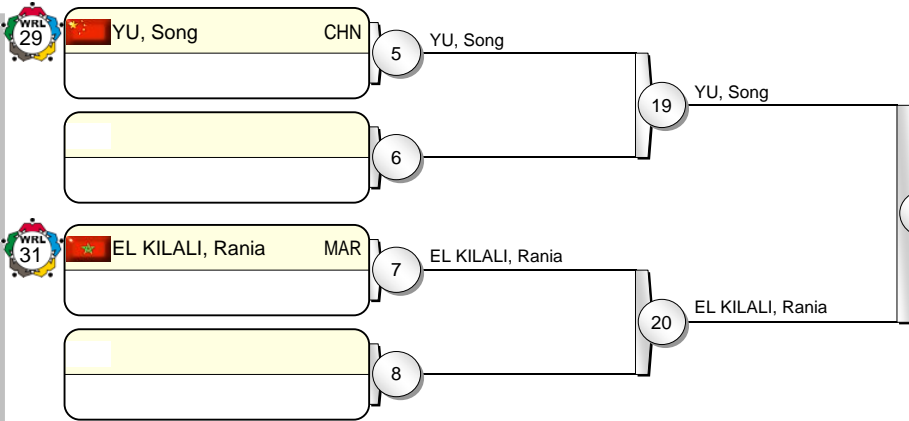

Pool C

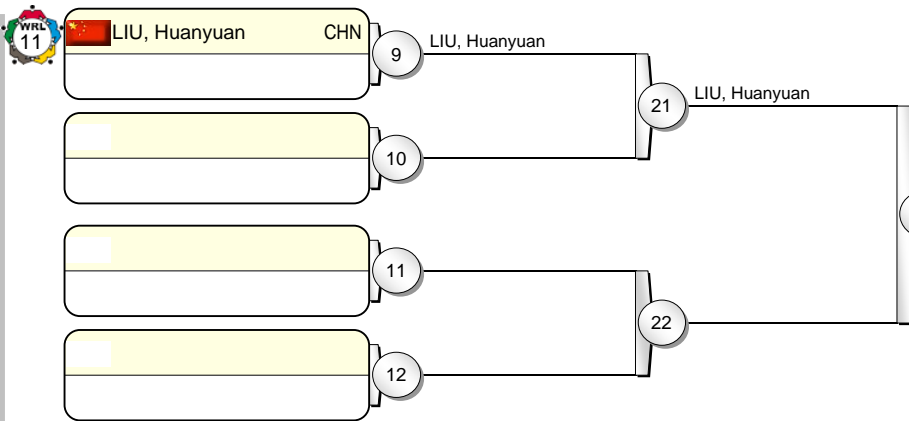

Pool D

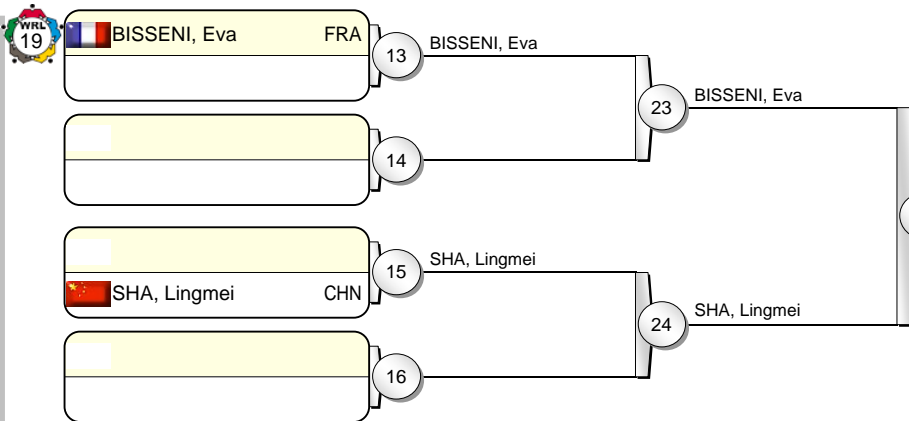

YU, Song CHN 31
100 / 001 [4:51]

LIU, Huanyuan CHN 30
100 / 000 [0:56]

Results

- | | | | |
|----|------------------|-----|--|
| 1. | YU, Song | CHN | |
| 2. | LIU, Huanyuan | CHN | |
| 3. | QIN, Qian | CHN | |
| 3. | BISSENI, Eva | FRA | |
| 5. | JO, Hye-Jin | KOR | |
| 5. | EL KILALI, Rania | MAR | |
| 5. | SHA, Lingmei | CHN | |