



IJF Grand Slam Tokyo 2011

(JPN Tokyo, 09-11 December 2011)

| -60 kg | | |
|---------------|------------------------|-----|
| 1. | YAMAMOTO, Hirofumi | JPN |
| 2. | KAWABATA, Ryo | JPN |
| 3. | HIRAOKA, Hiroaki | JPN |
| 3. | TAKATO, Naohisa | JPN |
| 5. | CHOI, Gwang-Hyeon | KOR |
| 5. | DAVAADORJ, Tumurkhuleg | MGL |
| 5. | KIM, Won Jin | KOR |
| 5. | MUSHKIYEV, Ilgar | AZE |

| -66 kg | | |
|---------------|----------------------------|-----|
| 1. | TAKAJO, Tomofumi | JPN |
| 2. | MOGUSHKOV, Musa | RUS |
| 3. | EBINUMA, Masashi | JPN |
| 3. | KHASHBAATAR, Tsagaanbaatar | MGL |
| 5. | CHOI, Min-Ho | KOR |
| 5. | DRAGIN, Dimitri | FRA |
| 5. | LIM, Sergey | KAZ |
| 5. | URIARTE, Sugoi | ESP |

| -73 kg | | |
|---------------|---------------------|-----|
| 1. | AKIMOTO, Hiroyuki | JPN |
| 2. | ISAEV, Mansur | RUS |
| 3. | NAKAYA, Riki | JPN |
| 3. | VAN TICHELDT, Dirk | BEL |
| 5. | ELMONT, Dex | NED |
| 5. | JURAKOBILOV, Navruz | UZB |
| 5. | KODZOKOV, Murat | RUS |
| 5. | LEGRAND, Ugo | FRA |

| -81 kg | | |
|---------------|--------------------|-----|
| 1. | KAWAKAMI, Tomohiro | JPN |
| 2. | GUILHEIRO, Leandro | BRA |
| 3. | MARESCH, Sven | GER |
| 3. | NAGASHIMA, Keita | JPN |
| 5. | BOZBAYEV, Islam | KAZ |
| 5. | BRUYERE, Francesco | ITA |
| 5. | NAKAI, Takahiro | JPN |
| 5. | TOMA, Sergiu | MDA |

| -90 kg | | |
|---------------|--------------------|-----|
| 1. | NISHIYAMA, Masashi | JPN |
| 2. | GONZALEZ, Asley | CUB |
| 3. | LEE, Kyu-Won | KOR |
| 3. | VOPROSOV, Kirill | RUS |
| 5. | ILIADIS, Ilias | GRE |
| 5. | MELONI, Roberto | ITA |
| 5. | ONO, Takashi | JPN |
| 5. | SONG, Dae-Nam | KOR |

| -100 kg | | |
|----------------|----------------------|-----|
| 1. | SAMOILOVICH, Sergei | RUS |
| 2. | HWANG, Hee-Tae | KOR |
| 3. | ANAI, Takamasa | JPN |
| 3. | TSIREKIDZE, Irakli | GEO |
| 5. | HAGA, Ryunosuke | JPN |
| 5. | KRPALEK, Lukas | CZE |
| 5. | NAIDAN, Tuvshinbayar | MGL |
| 5. | SAYIDOV, Ramziddin | UZB |

| +100 kg | | |
|----------------|----------------------|-----|
| 1. | MIKHAYLIN, Alexander | RUS |
| 2. | CHO, Guham | KOR |
| 3. | SILVA, Rafael | BRA |
| 3. | TANGRIEV, Abdullo | UZB |
| 5. | CERAJ, Matjaz | SLO |
| 5. | ISHII, Ryuta | JPN |
| 5. | KIM, Sung-Min | KOR |
| 5. | VERBIJ, Luuk | NED |



IJF Grand Slam Tokyo 2011

(JPN Tokyo, 09-11 December 2011)

| -48 kg | | |
|---------------|-----------------------|-----|
| 1. | ASAMI, Haruna | JPN |
| 2. | FUKUMI, Tomoko | JPN |
| 3. | JEONG, Bo Kyeong | KOR |
| 3. | VAN SNICK, Charline | BEL |
| 5. | CHUNG, Jung-Yeon | KOR |
| 5. | CSERNOVICZKI, Eva | HUN |
| 5. | KONDRATYEVA, Nataliya | RUS |
| 5. | YAMAZAKI, Tamami | JPN |

| -52 kg | | |
|---------------|----------------------|-----|
| 1. | MIYAKAWA, Takumi | JPN |
| 2. | GNETO, Priscilla | FRA |
| 3. | BERMOY ACOSTA, Yanet | CUB |
| 3. | HASHIMOTO, Yuki | JPN |
| 5. | FORCINITI, Rosalba | ITA |
| 5. | GOMEZ, Laura | ESP |
| 5. | NAKAMURA, Misato | JPN |
| 5. | TARANGUL, Romy | GER |

| -57 kg | | |
|---------------|-----------------------|-----|
| 1. | MATSUMOTO, Kaori | JPN |
| 2. | SATO, Aiko | JPN |
| 3. | SILVA, Rafaela | BRA |
| 3. | YAMAMOTO, Anzu | JPN |
| 5. | BOUKOUVALA, Ioulietta | GRE |
| 5. | GASIMOVA, Kifayat | AZE |
| 5. | KIM, Jan-Di | KOR |
| 5. | LOKO, Sarah | FRA |

| -63 kg | | |
|---------------|-------------------------|-----|
| 1. | ZOLNIR, Urska | SLO |
| 2. | UENO, Yoshie | JPN |
| 3. | TANAKA, Miki | JPN |
| 3. | WILLEBOORDSE, Elisabeth | NED |
| 5. | AGBEGNENOU, Clarisse | FRA |
| 5. | GERBI, Yarden | ISR |
| 5. | MALZAHN, Claudia | GER |
| 5. | SCHLESINGER, Alice | ISR |

| -70 kg | | |
|---------------|-------------------|-----|
| 1. | UENO, Tomoe | JPN |
| 2. | BLANCO, Cecilia | ESP |
| 3. | KLYS, Katarzyna | POL |
| 3. | TACHIMOTO, Haruka | JPN |
| 5. | KIM, Seong-Yeon | KOR |
| 5. | ONO, Yoko | JPN |
| 5. | PASQUET, Marie | FRA |
| 5. | THIELE, Kerstin | GER |

| -78 kg | | |
|---------------|-------------------|-----|
| 1. | OGATA, Akari | JPN |
| 2. | HARRISON, Kayla | USA |
| 3. | AGUIAR, Mayra | BRA |
| 3. | WOLLERT, Heide | GER |
| 5. | MALZAHN, Luise | GER |
| 5. | SATO, Ruika | JPN |
| 5. | VELENSEK, Anamari | SLO |
| 5. | VERKERK, Marhinde | NED |

| +78 kg | | |
|---------------|--------------------|-----|
| 1. | SUGIMOTO, Mika | JPN |
| 2. | TACHIMOTO, Megumi | JPN |
| 3. | KIM, Na-Young | KOR |
| 3. | POLAVDER, Lucija | SLO |
| 5. | BLANCO, Giovanna | VEN |
| 5. | BRYANT, Karina | GBR |
| 5. | HASHIGUCHI, Nanami | JPN |
| 5. | KIM, Ji-Youn | KOR |



IJF Grand Slam Tokyo 2011

(JPN Tokyo, 09-11 December 2011)

-60 kg

39 Judoka

Pool A

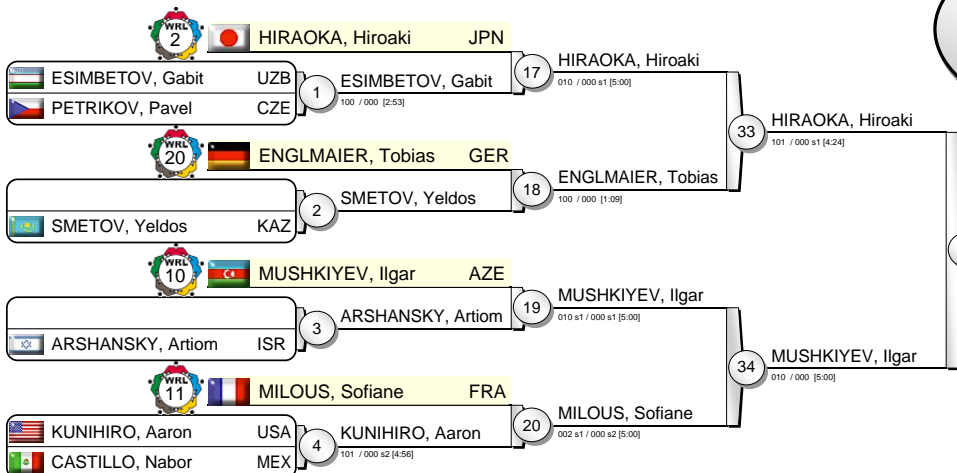

Pool B

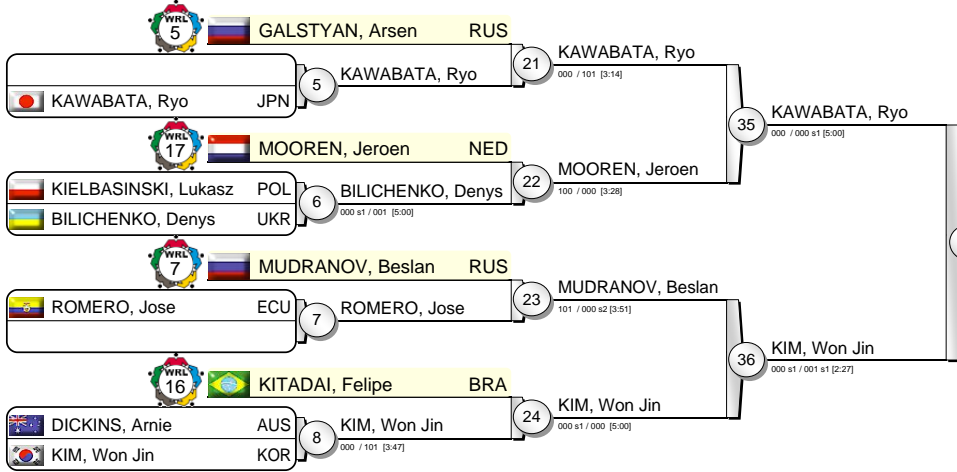

Pool C

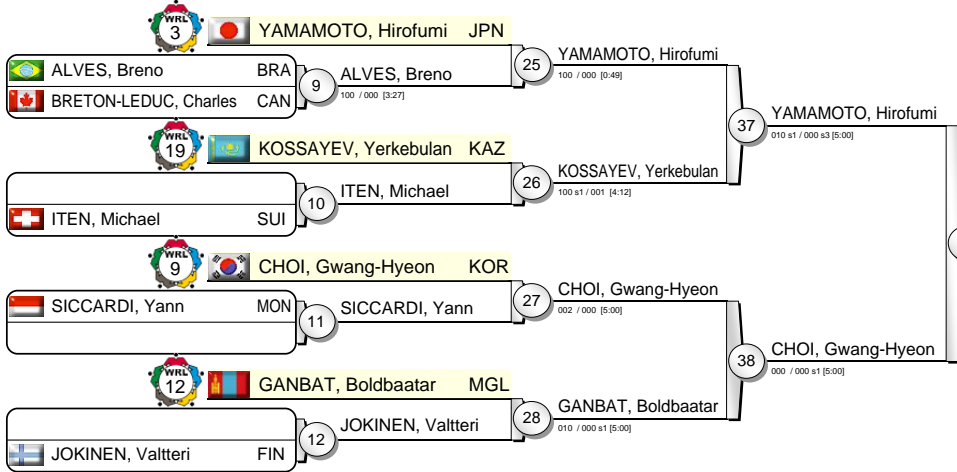

Pool D

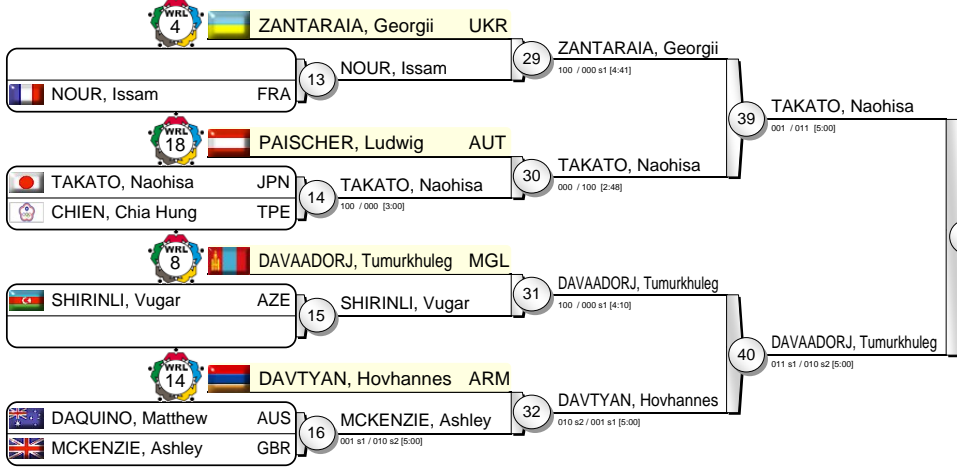

YAMAMOTO, Hirofumi

000 s1 / 100 [4:26]

47

Results

1. YAMAMOTO, Hirofumi JPN
2. KAWABATA, Ryo JPN
3. HIRAOKA, Hiroaki JPN
3. TAKATO, Naohisa JPN
5. MUSHKIYEV, Ilgar AZE
5. KIM, Won Jin KOR
5. CHOI, Gwang-Hyeon KOR
5. DAVAADORJ, Tumurkhuleg MGL





IJF Grand Slam Tokyo 2011

(JPN Tokyo, 09-11 December 2011)

-66 kg
38 Judoka

Pool A

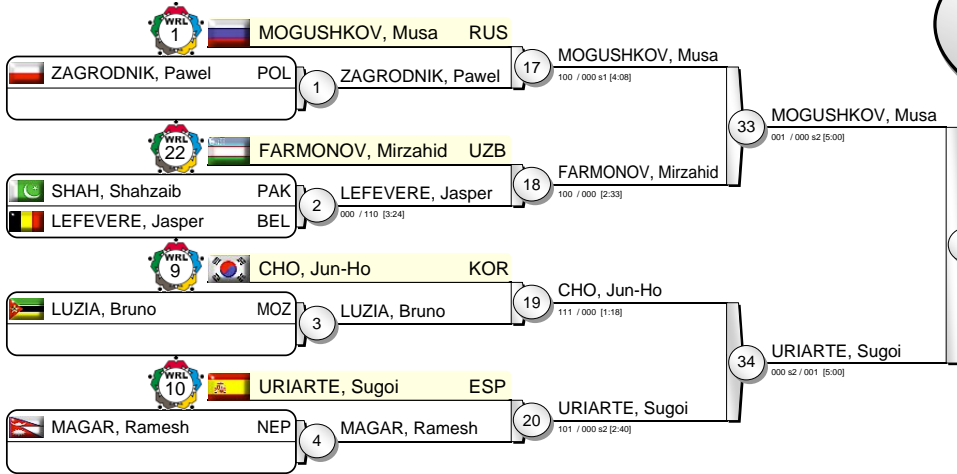

Pool B

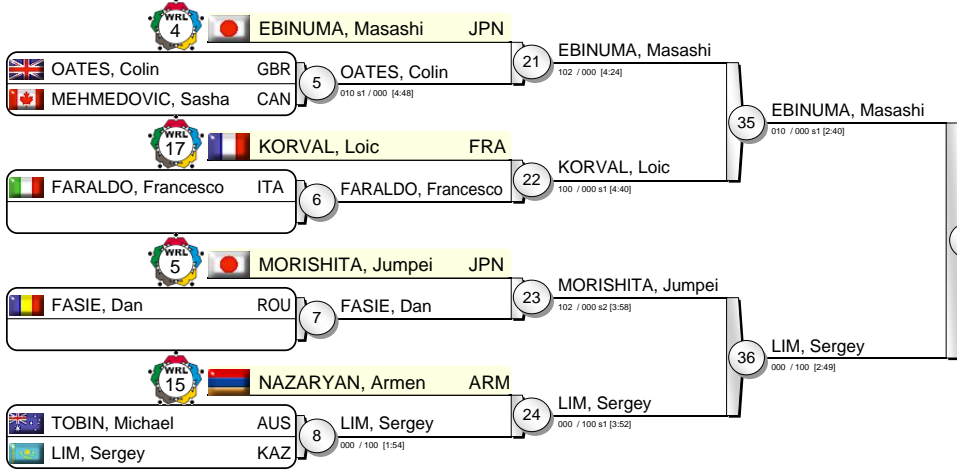

Pool C

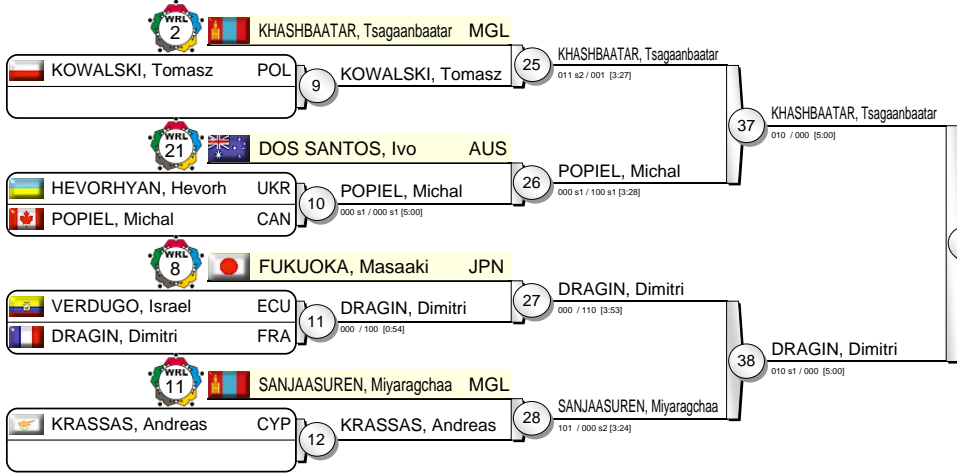

Pool D

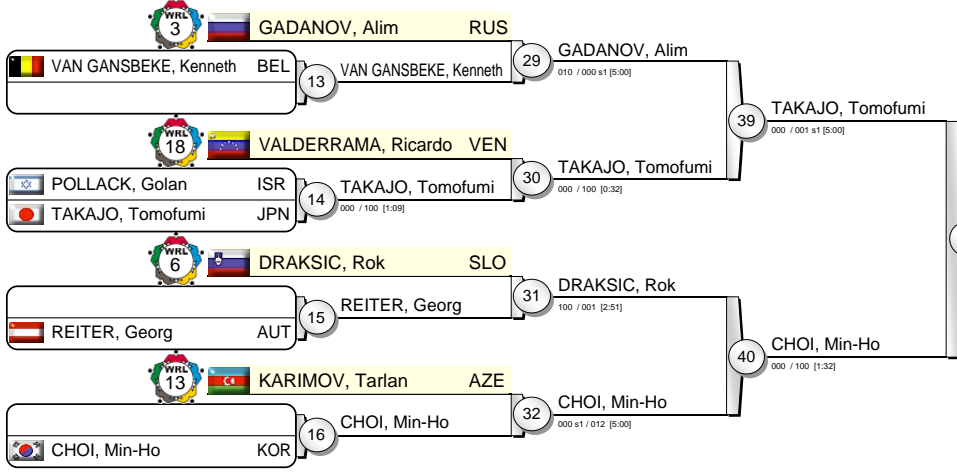

TAKAJO, Tomofumi
010 / 100 [2:49] (47)

Results

- TAKAJO, Tomofumi JPN
- MOGUSHKOV, Musa RUS
- EBINUMA, Masashi JPN
- KHASHBAATAR, Tsagaanbaatar MGL
- URIARTE, Sugoï ESP
- LIM, Sergey KAZ
- DRAGIN, Dimitri FRA
- CHOI, Min-Ho KOR





IJF Grand Slam Tokyo 2011

(JPN Tokyo, 09-11 December 2011)

-73 kg
39 Judoka

Pool A

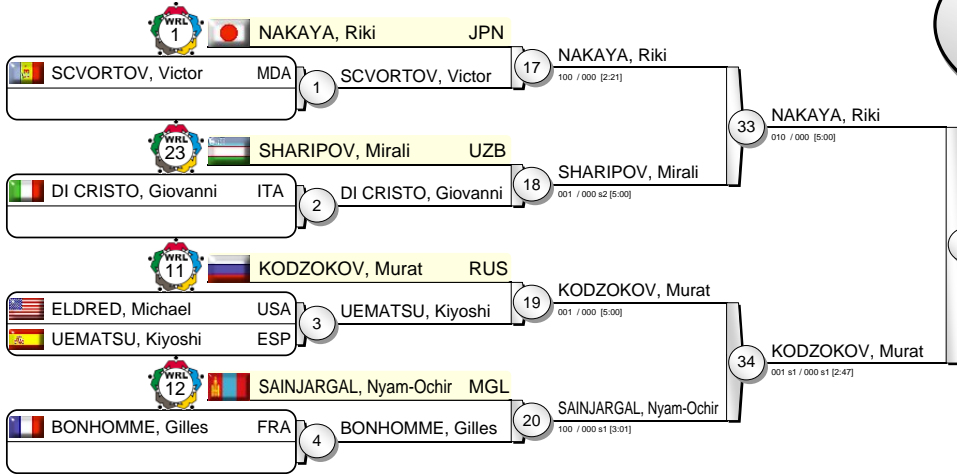

Pool B

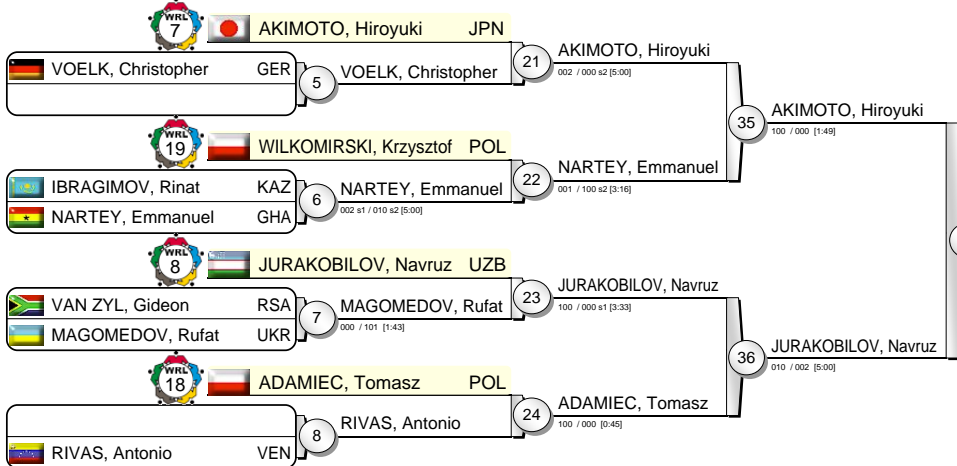

Pool C

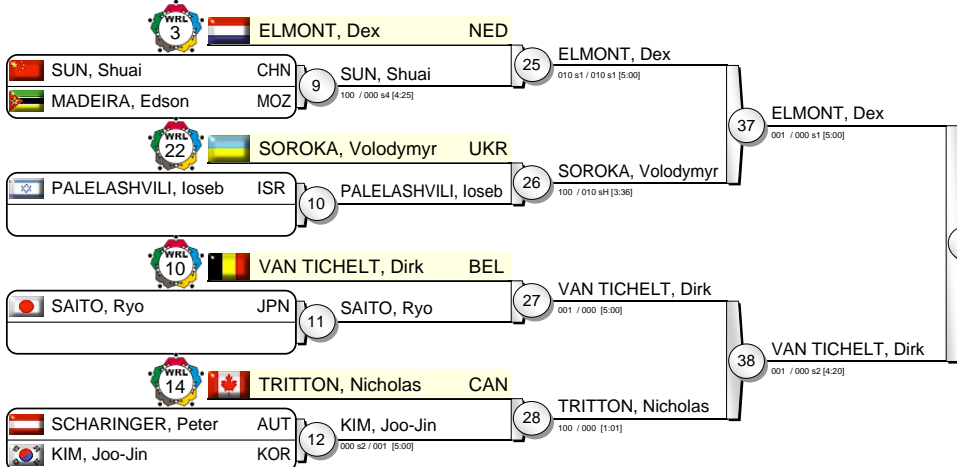

Pool D

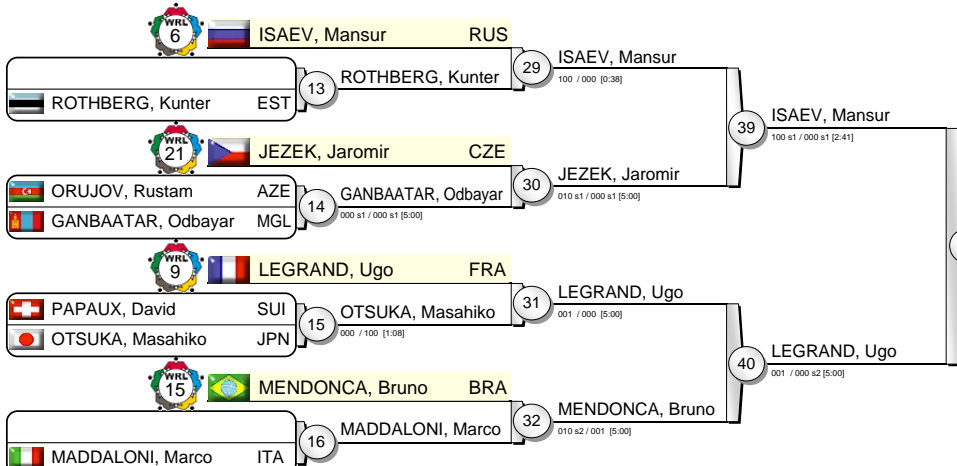

AKIMOTO, Hiroyuki (47)

Results

- AKIMOTO, Hiroyuki (JPN)
- ISAEV, Mansur (RUS)
- NAKAYA, Riki (JPN)
- VAN TICHELT, Dirk (BEL)
- KODZOKOV, Murat (RUS)
- JURAKOBILOV, Navruz (UZB)
- ELMONT, Dex (NED)
- LEGRAND, Ugo (FRA)





IJF Grand Slam Tokyo 2011

(JPN Tokyo, 09-11 December 2011)

-81 kg
43 Judoka

Pool A

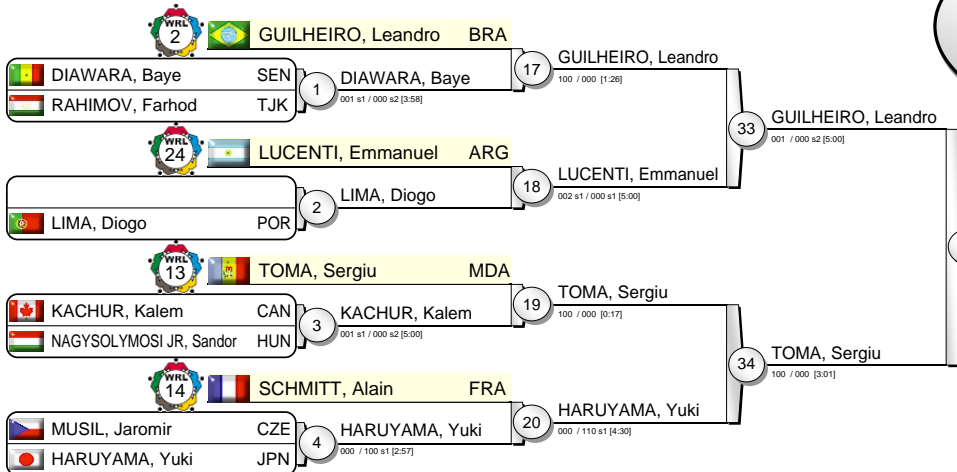

Pool B

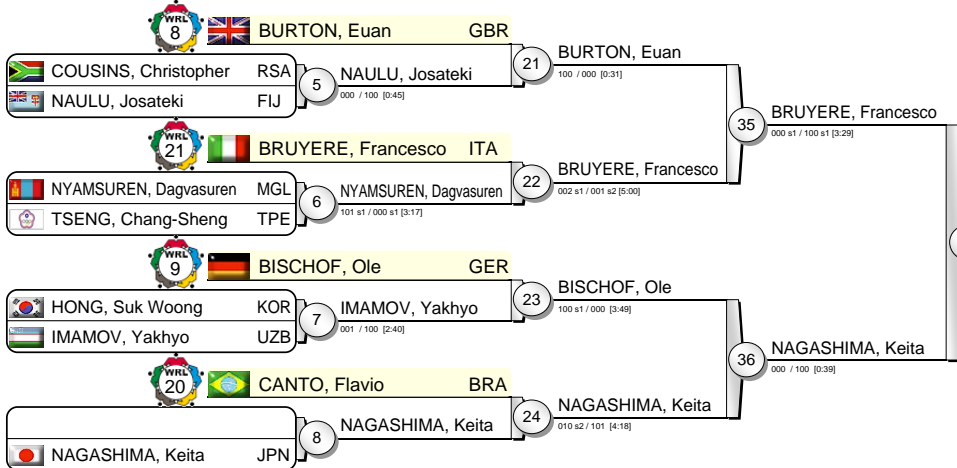

Pool C

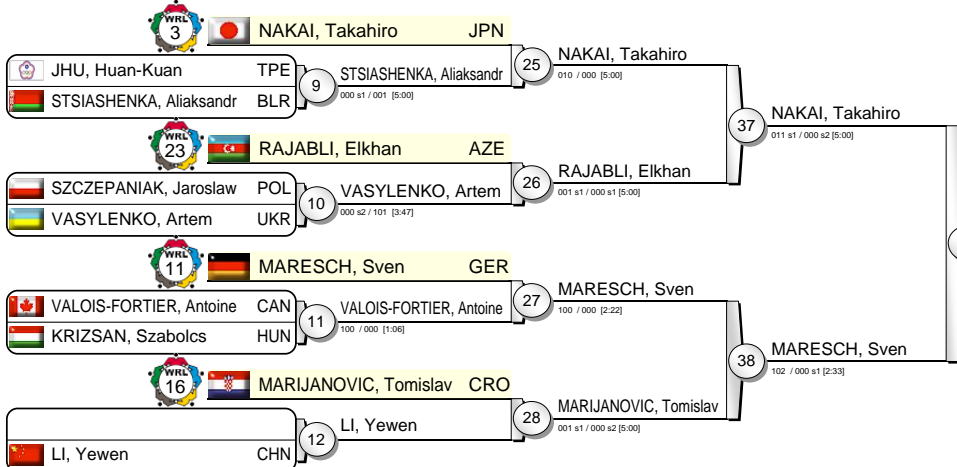

Pool D

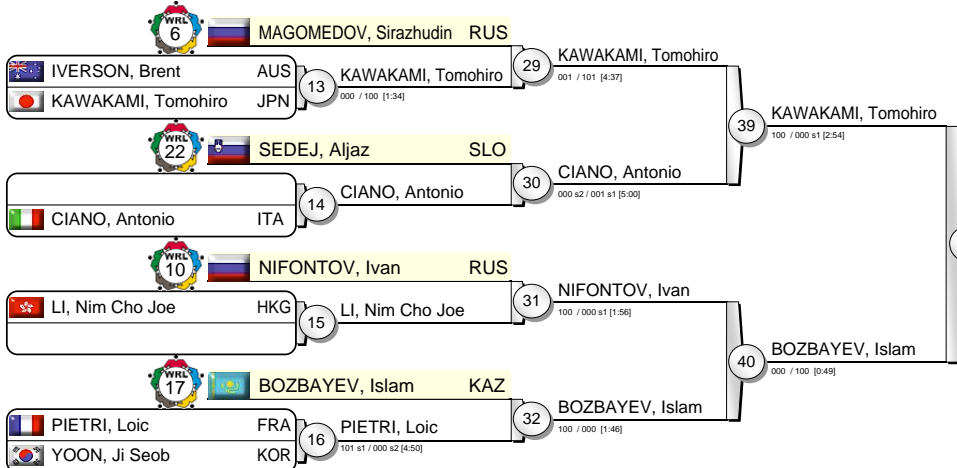

KAWAKAMI, Tomohiro
0:01 / 1:00 [3:50] **47**

KAWAKAMI, Tomohiro
0:00 s1 / 0:11 [5:00] **46**

Results

- KAWAKAMI, Tomohiro JPN
- GUILHEIRO, Leandro BRA
- NAGASHIMA, Keita JPN
- MARESCH, Sven GER
- TOMA, Sergiu MDA
- BRUYERE, Francesco ITA
- NAKAI, Takahiro JPN
- BOZBAYEV, Islam KAZ





IJF Grand Slam Tokyo 2011

(JPN Tokyo, 09-11 December 2011)

-90 kg

31 Judoka

Pool A

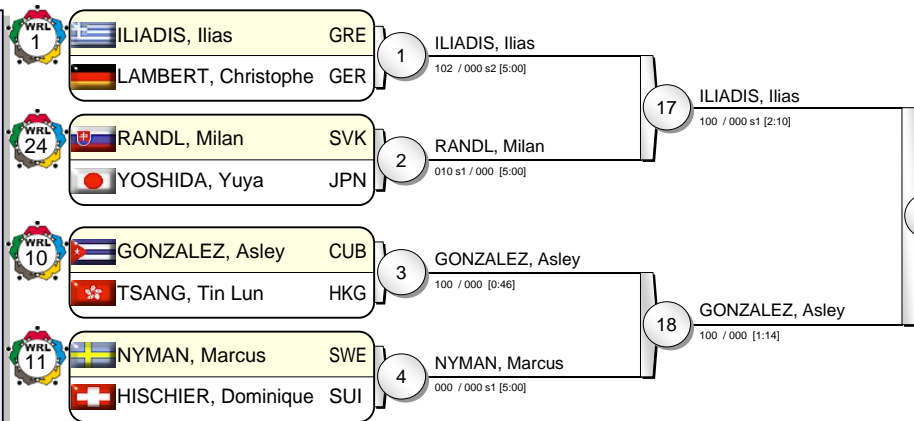

Pool B

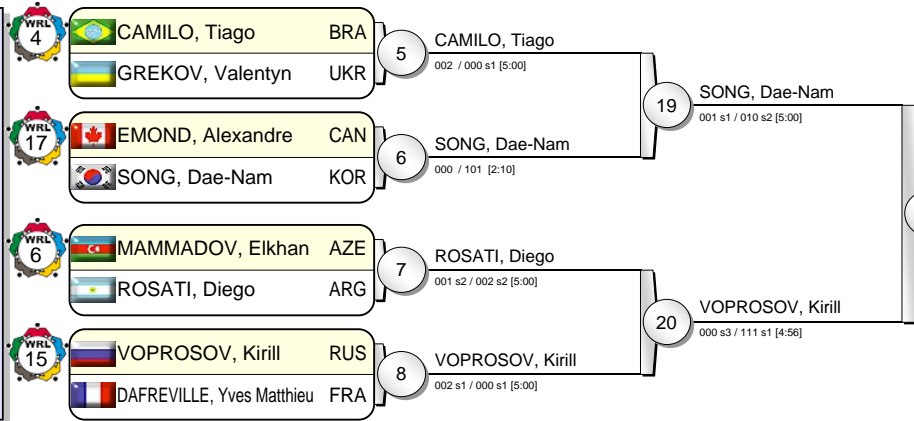

Pool C

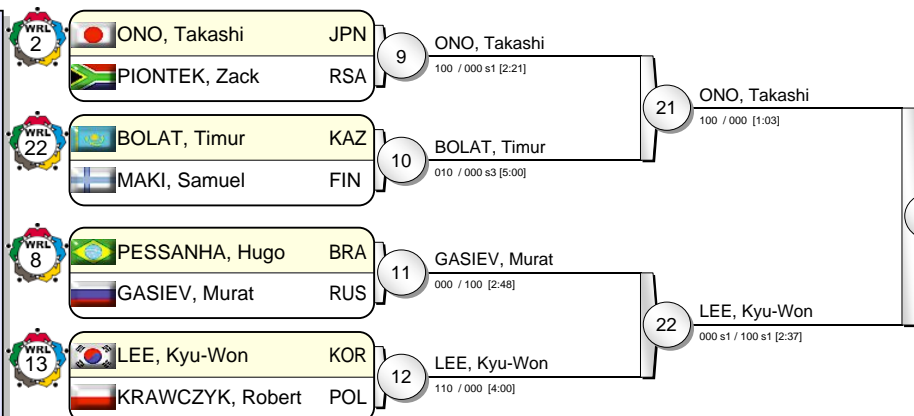

Pool D

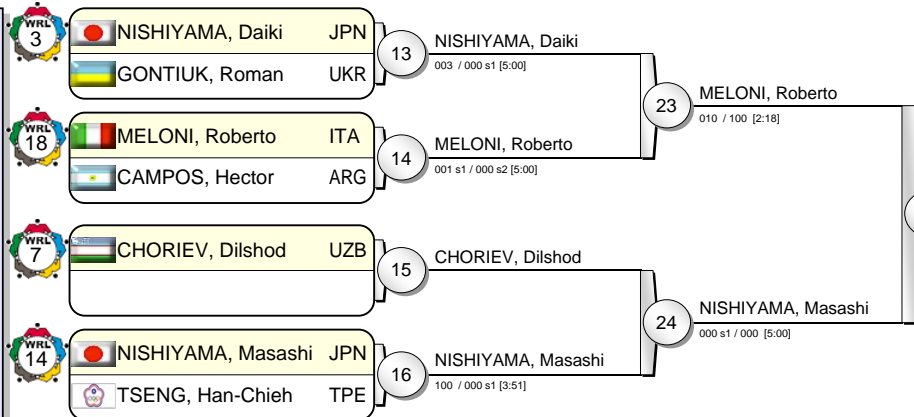

NISHIYAMA, Masashi JPN 31
000 s1 / 000 [5:00]

30 NISHIYAMA, Masashi
000 / 001 [2:34]

Results

- | | | | |
|----|--------------------|-----|--|
| 1. | NISHIYAMA, Masashi | JPN | |
| 2. | GONZALEZ, Asley | CUB | |
| 3. | VOPROSOV, Kirill | RUS | |
| 3. | LEE, Kyu-Won | KOR | |
| 5. | ILIADIS, Ilias | GRE | |
| 5. | SONG, Dae-Nam | KOR | |
| 5. | ONO, Takashi | JPN | |
| 5. | MELONI, Roberto | ITA | |





IJF Grand Slam Tokyo 2011

(JPN Tokyo, 09-11 December 2011)

-100 kg

32 Judoka

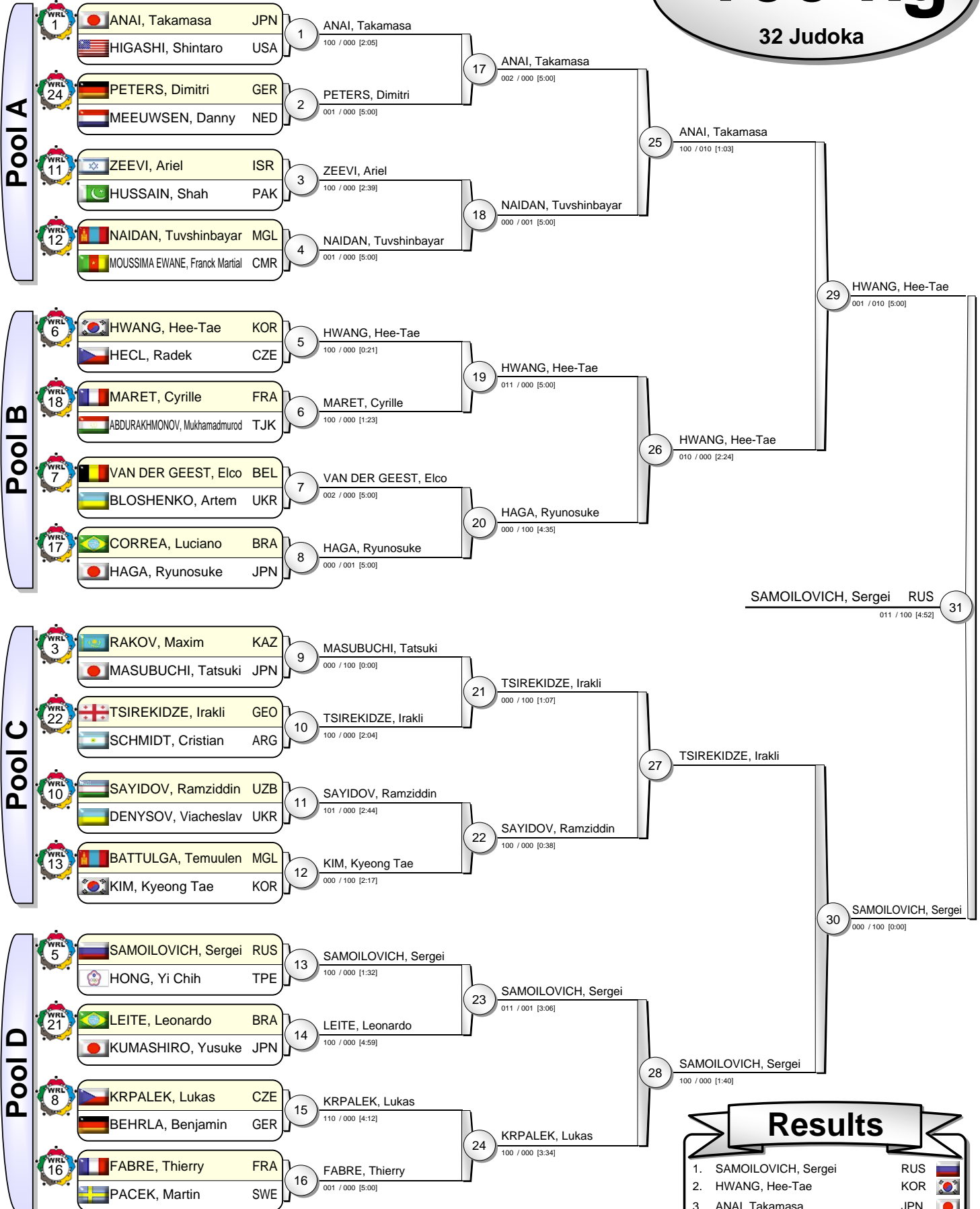

SAMOILOVICH, Sergei RUS 31
011 / 100 [4:52]

30 SAMOILOVICH, Sergei
000 / 100 [0:00]

Results

- | | | |
|-------------------------|-----|--|
| 1. SAMOILOVICH, Sergei | RUS | |
| 2. HWANG, Hee-Tae | KOR | |
| 3. ANAI, Takamasa | JPN | |
| 3. TSIREKIDZE, Irakli | GEO | |
| 5. NAIDAN, Tuvshinbayar | MGL | |
| 5. HAGA, Ryunosuke | JPN | |
| 5. SAYIDOV, Ramziddin | UZB | |
| 5. KRPALEK, Lukas | CZE | |





IJF Grand Slam Tokyo 2011

(JPN Tokyo, 09-11 December 2011)

+100 kg

25 Judoka

Pool A

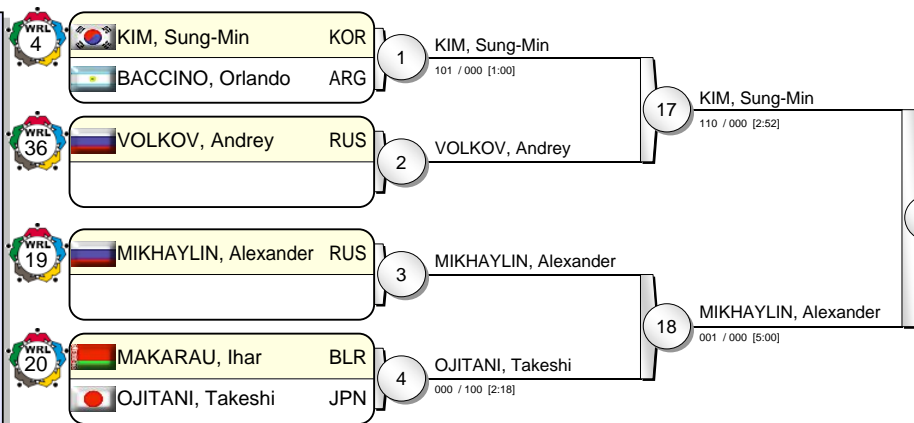

Pool B

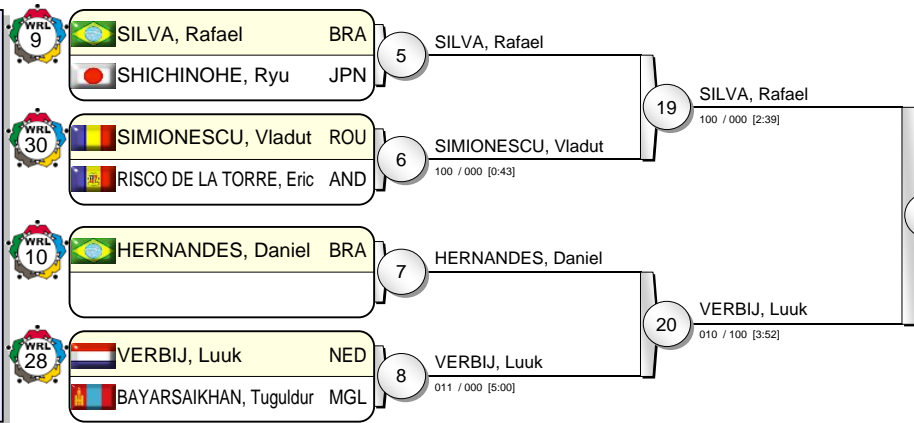

Pool C

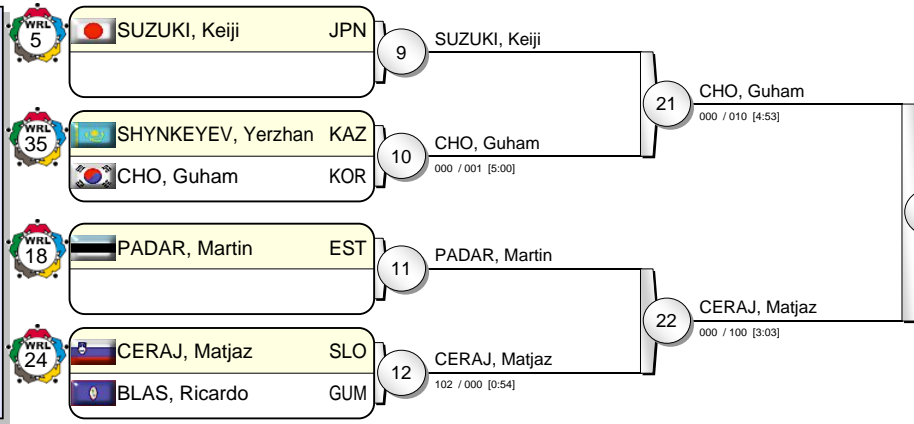

Pool D

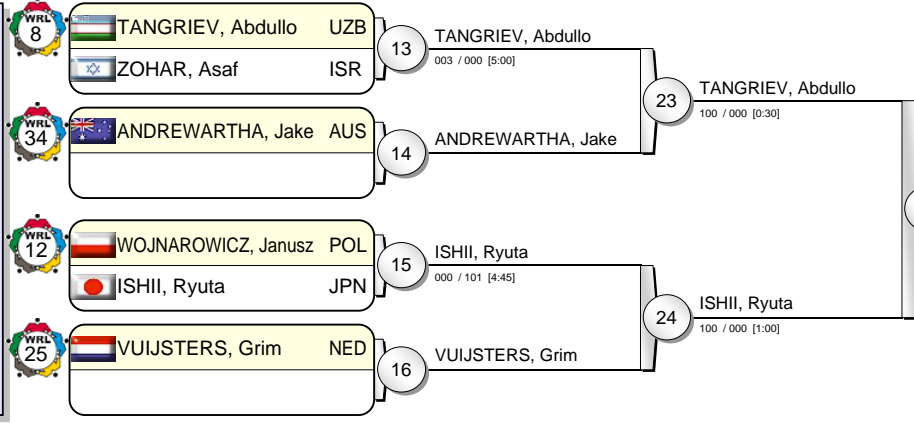

MIKHAYLIN, Alexander RUS 31
100 / 000 [4:39]

30 CHO, Guham
001 / 000 [5:00]

Results

1. MIKHAYLIN, Alexander RUS
2. CHO, Guham KOR
3. SILVA, Rafael BRA
3. TANGRIEV, Abdullo UZB
5. KIM, Sung-Min KOR
5. VERBIJ, Luuk NED
5. CERAJ, Matjaz SLO
5. ISHII, Ryuta JPN





IJF Grand Slam Tokyo 2011

(JPN Tokyo, 09-11 December 2011)

-48 kg

21 Judoka

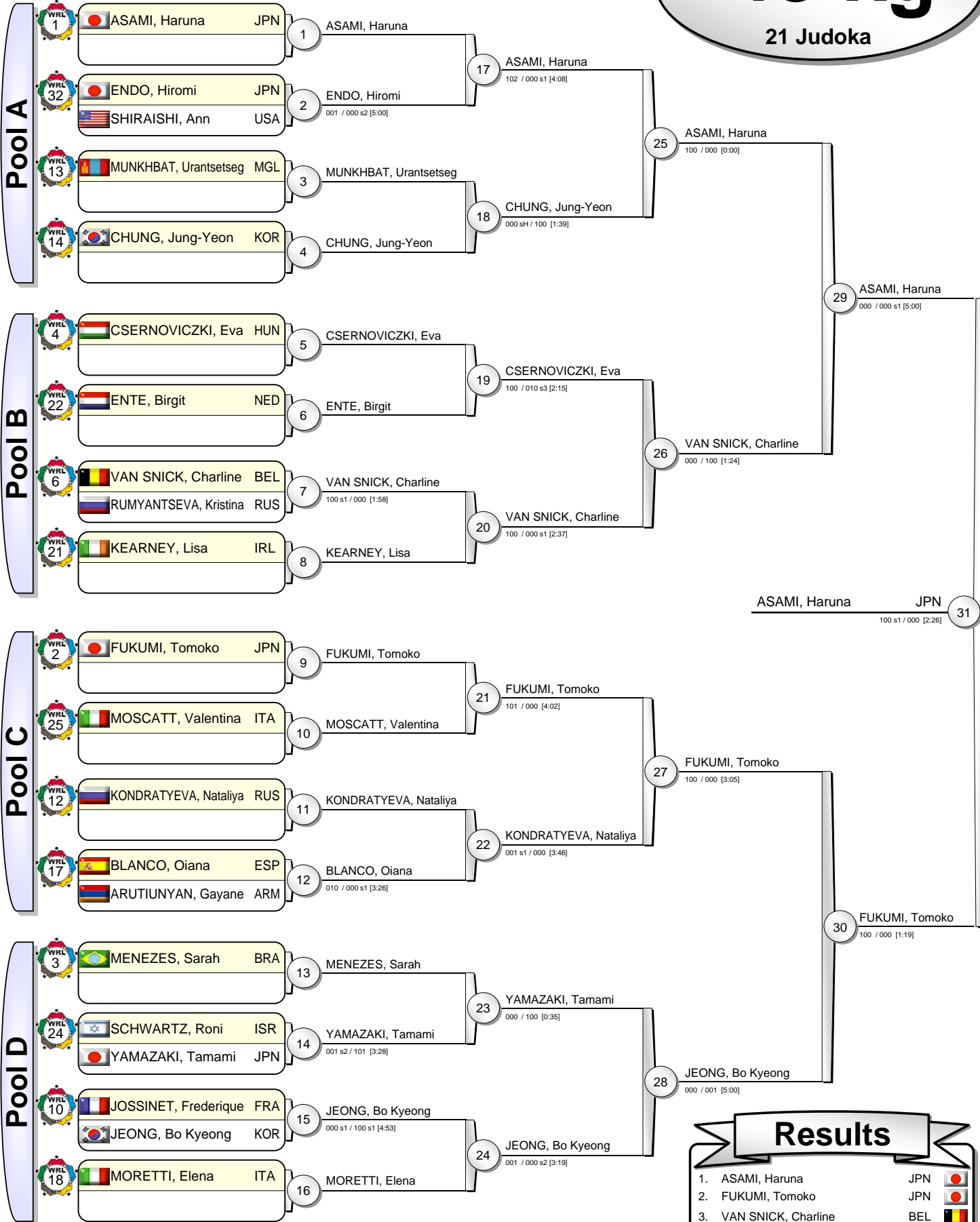

Results

- ASAMI, Haruna (JPN)
- FUKUMI, Tomoko (JPN)
- VAN SNICK, Charline (BEL)
- JEONG, Bo Kyeong (KOR)
- CHUNG, Jung-Yeon (KOR)
- CSERNOVICZKI, Eva (HUN)
- KONDRATYEVA, Nataliya (RUS)
- YAMAZAKI, Tamami (JPN)





IJF Grand Slam Tokyo 2011

(JPN Tokyo, 09-11 December 2011)

-52 kg

26 Judoka

Pool A

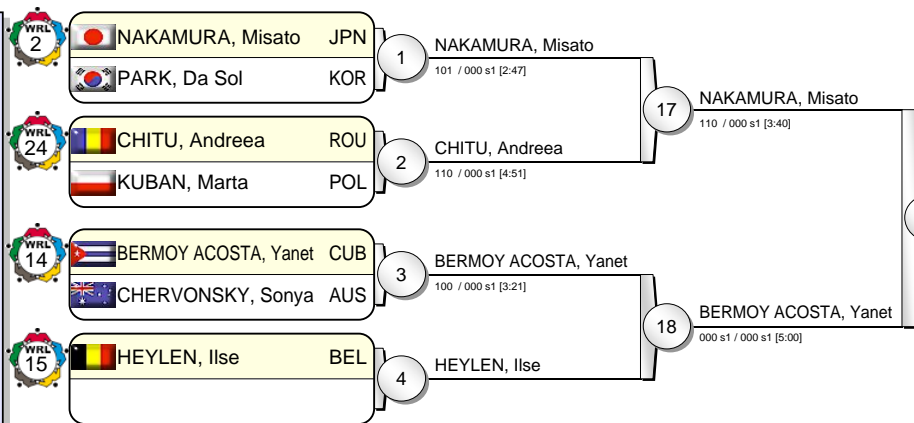

Pool B

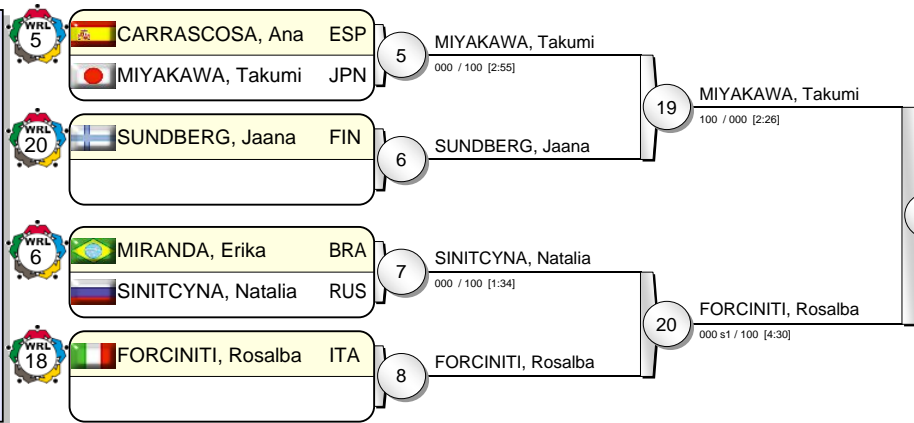

Pool C

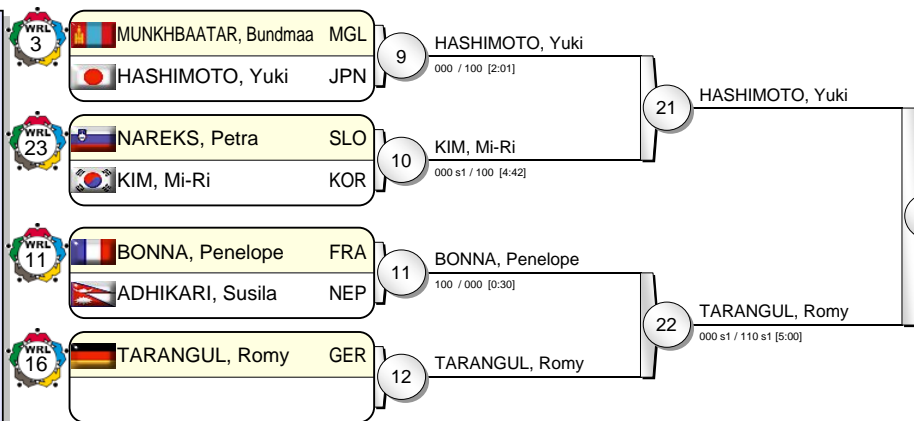

Pool D

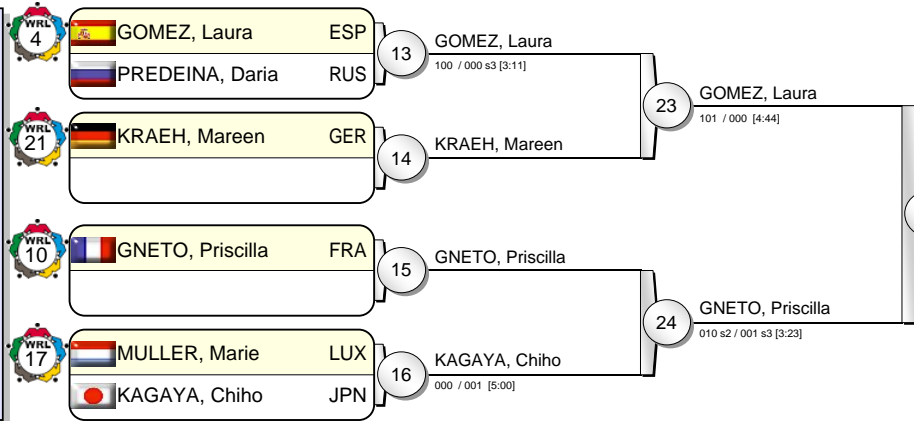

MIYAKAWA, Takumi JPN 31
100 / 000 [3:40]

Results

- MIYAKAWA, Takumi JPN
- GNETO, Priscilla FRA
- BERMOY ACOSTA, Yanet CUB
- HASHIMOTO, Yuki JPN
- NAKAMURA, Misato JPN
- FORCINITI, Rosalba ITA
- TARANGUL, Romy GER
- GOMEZ, Laura ESP





IJF Grand Slam Tokyo 2011

(JPN Tokyo, 09-11 December 2011)

-57 kg

26 Judoka

Pool A

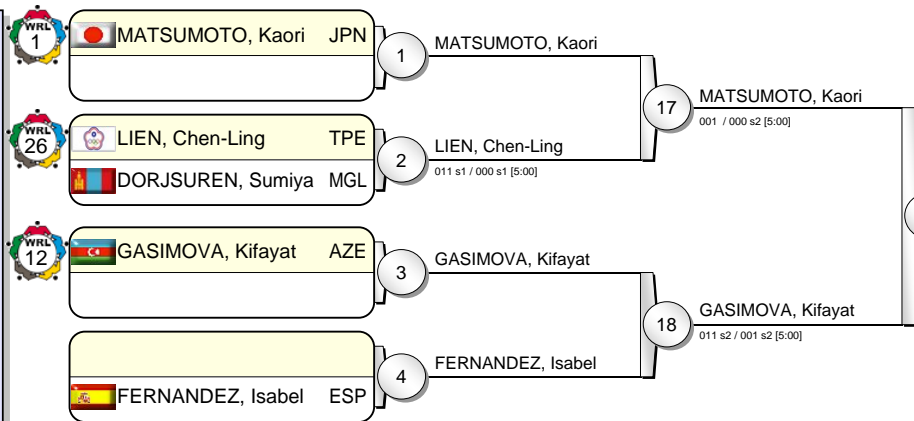

Pool B

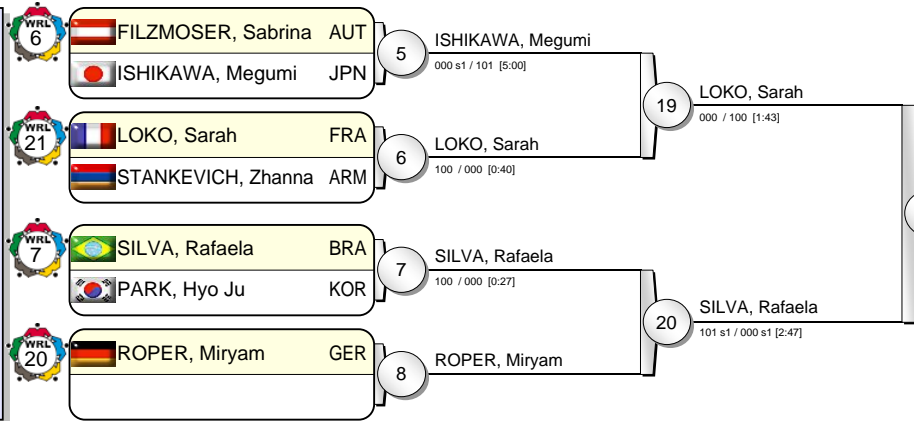

Pool C

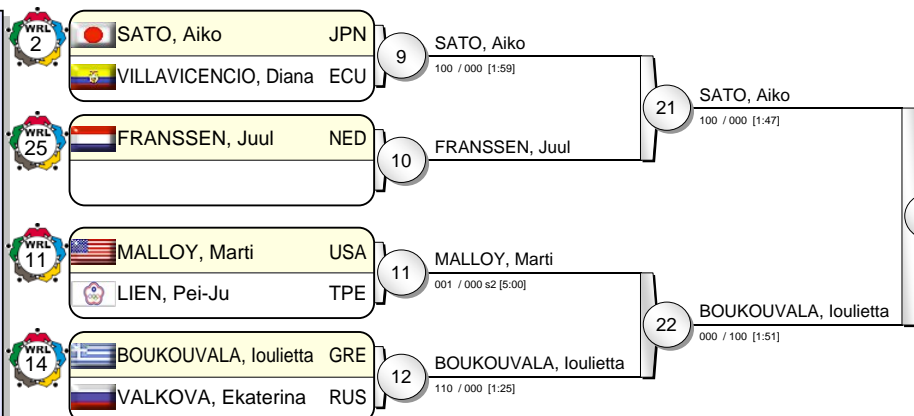

Pool D

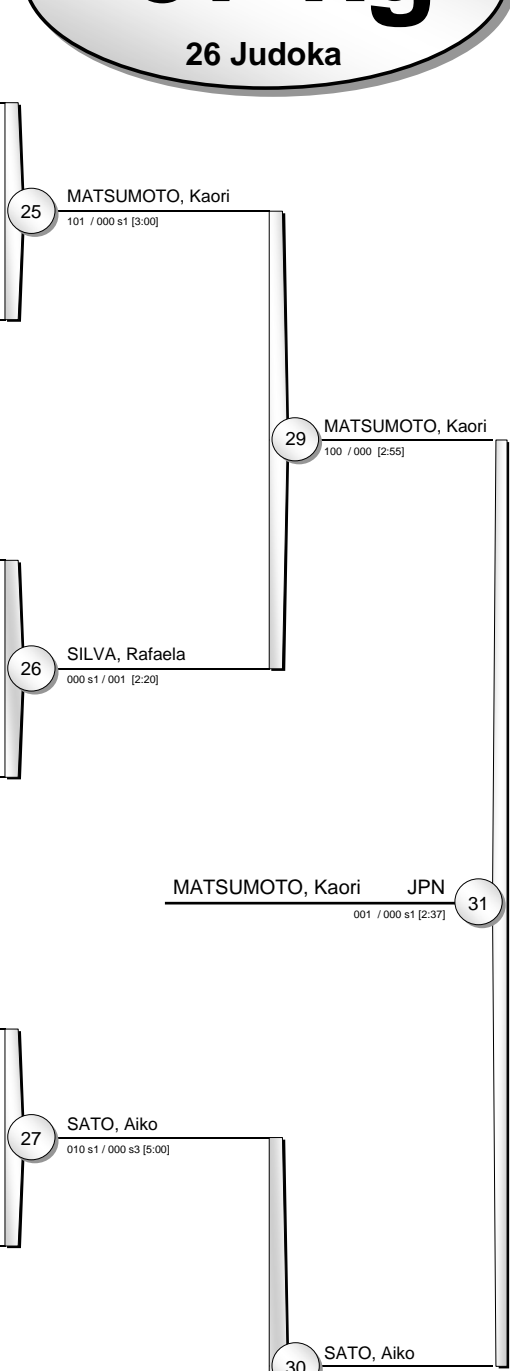
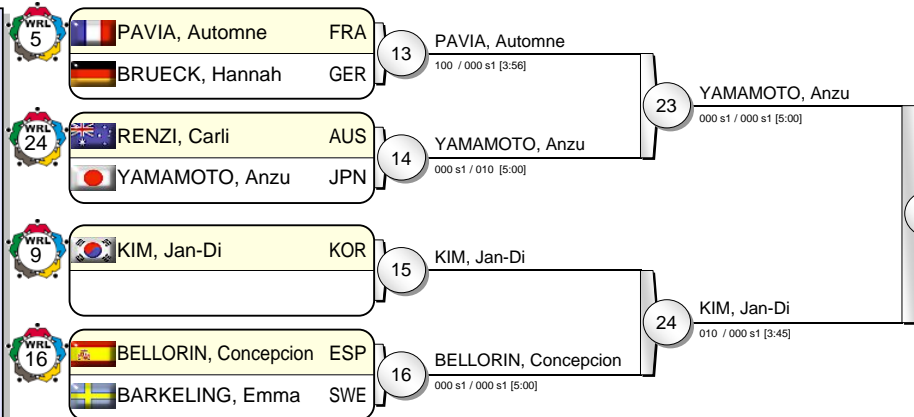

MATSUMOTO, Kaori JPN 31
001 / 000 s1 [2:37]

Results

- MATSUMOTO, Kaori JPN
- SATO, Aiko JPN
- SILVA, Rafaela BRA
- YAMAMOTO, Anzu JPN
- GASIMOVA, Kifayat AZE
- LOKO, Sarah FRA
- BOUKOUVALA, Ioulietta GRE
- KIM, Jan-Di KOR





IJF Grand Slam Tokyo 2011

(JPN Tokyo, 09-11 December 2011)

-63 kg

29 Judoka

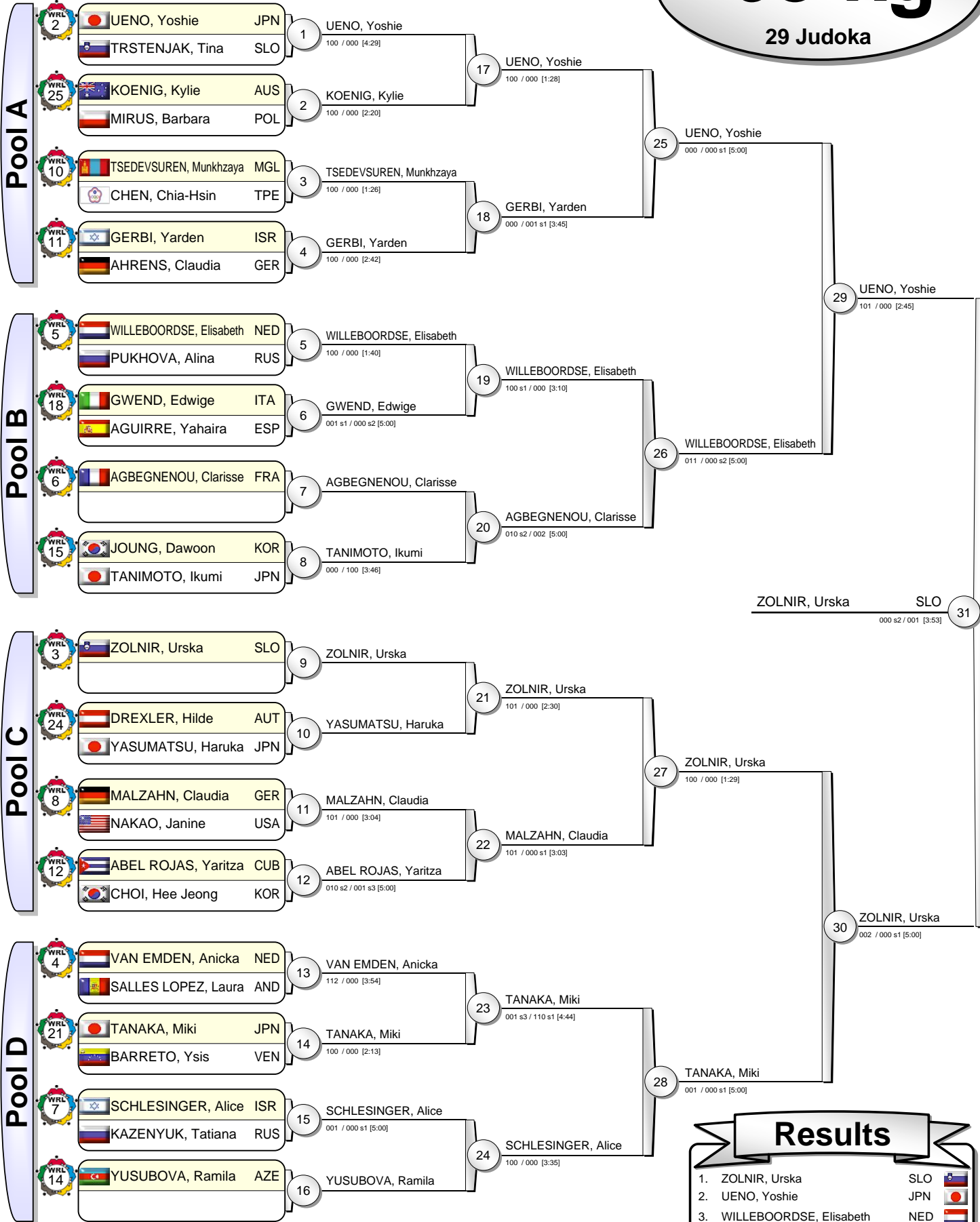

Results

- | | | |
|----------------------------|-----|--|
| 1. ZOLNIR, Urska | SLO | |
| 2. UENO, Yoshie | JPN | |
| 3. WILLEBOORDSE, Elisabeth | NED | |
| 3. TANAKA, Miki | JPN | |
| 5. GERBI, Yarden | ISR | |
| 5. AGBEGNENOU, Clarisse | FRA | |
| 5. MALZAHN, Claudia | GER | |
| 5. SCHLESINGER, Alice | ISR | |





IJF Grand Slam Tokyo 2011

(JPN Tokyo, 09-11 December 2011)

-70 kg

19 Judoka

Pool A

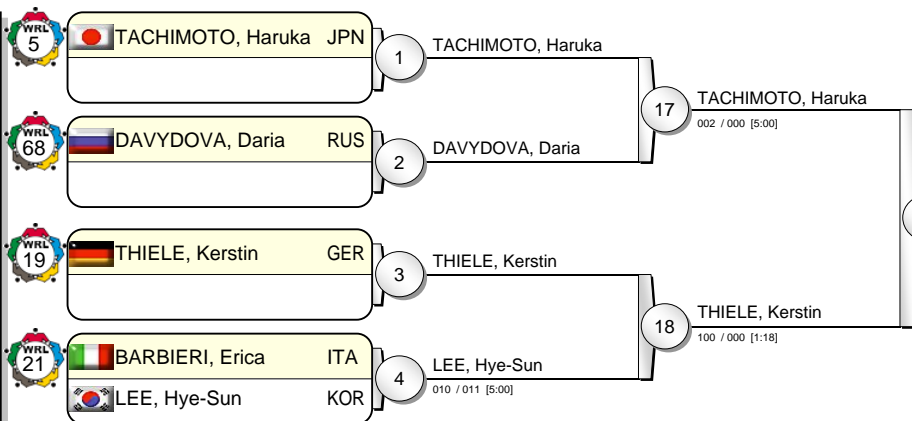

Pool B

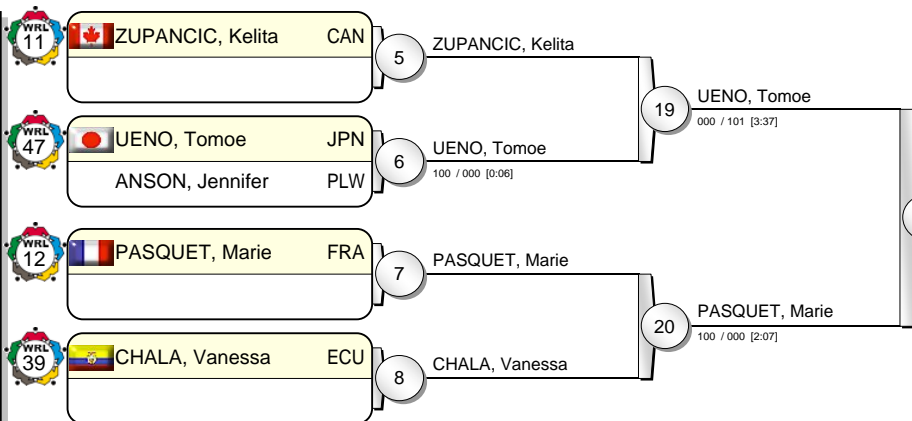

Pool C

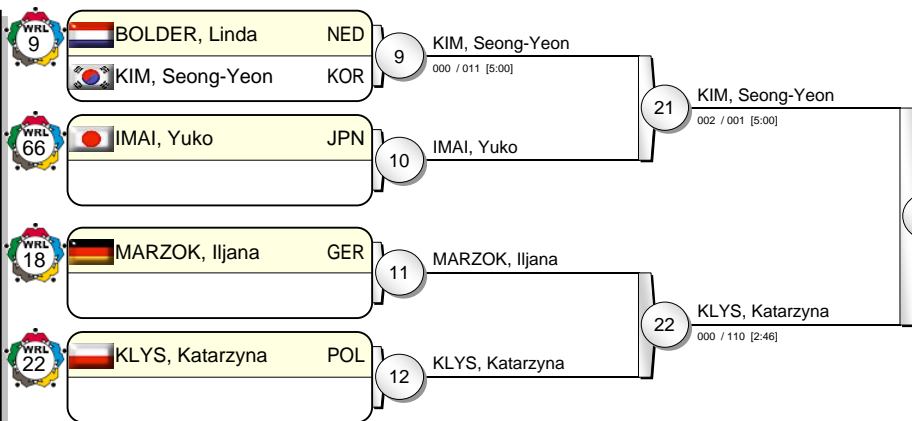

Pool D

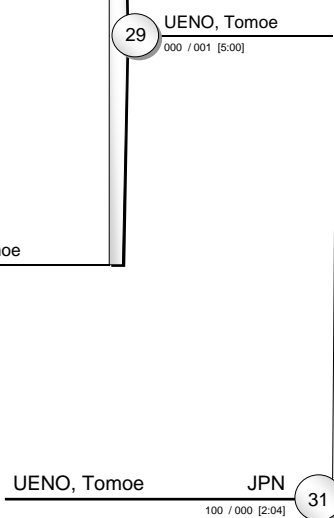
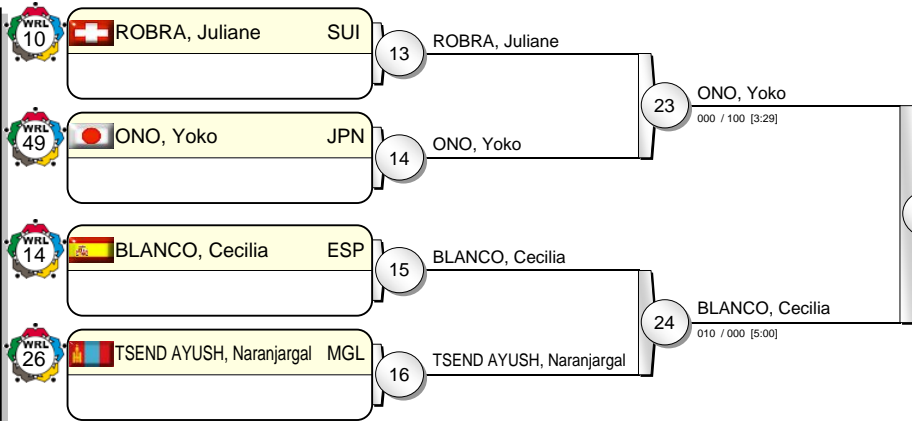

UENO, Tomoe JPN 31
100 / 000 [2:04]

Results

- | | | | |
|----|-------------------|-----|--|
| 1. | UENO, Tomoe | JPN | |
| 2. | BLANCO, Cecilia | ESP | |
| 3. | TACHIMOTO, Haruka | JPN | |
| 3. | KLYS, Katarzyna | POL | |
| 5. | THIELE, Kerstin | GER | |
| 5. | PASQUET, Marie | FRA | |
| 5. | KIM, Seong-Yeon | KOR | |
| 5. | ONO, Yoko | JPN | |





IJF Grand Slam Tokyo 2011

(JPN Tokyo, 09-11 December 2011)

-78 kg

17 Judoka

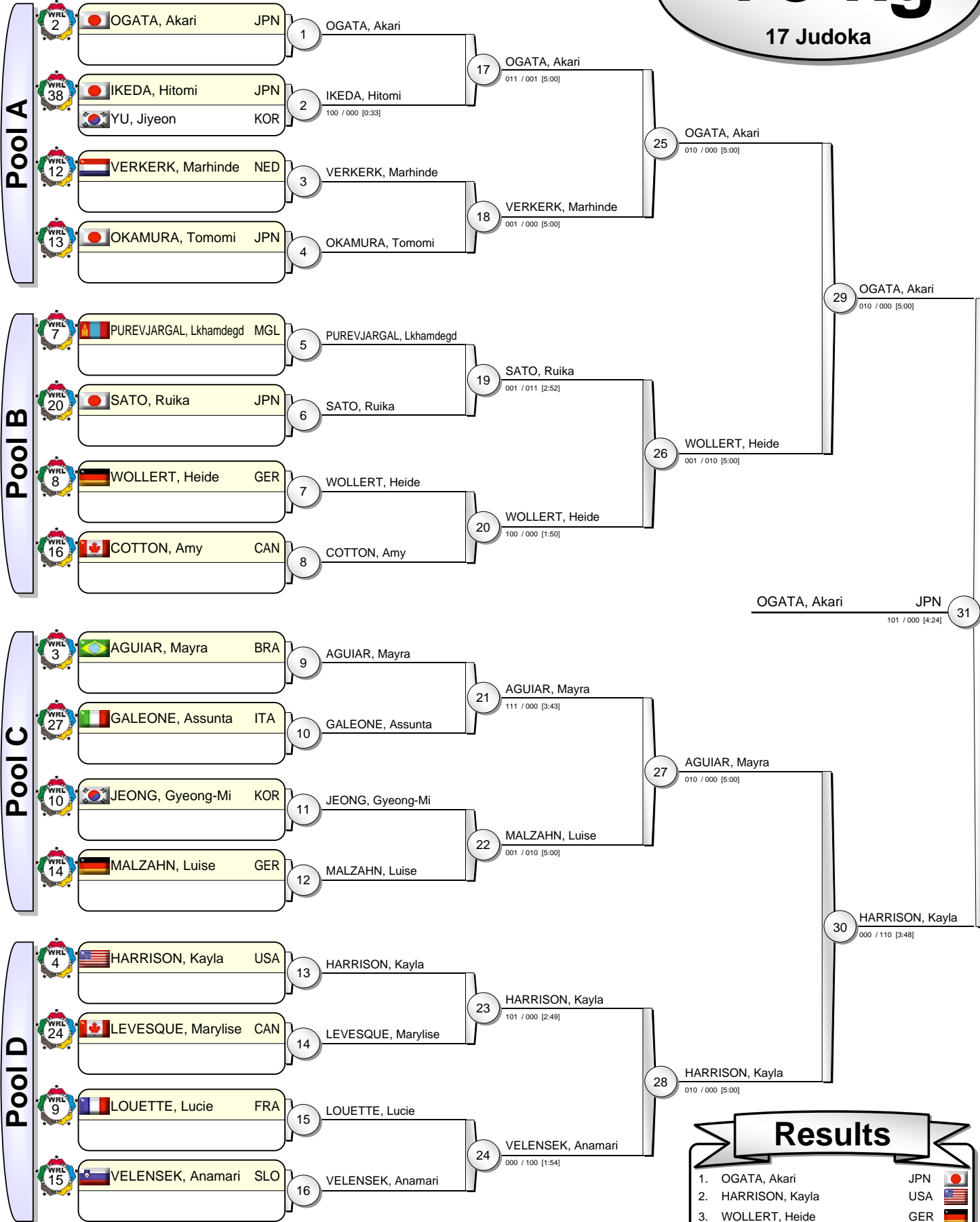

Results

- | | | |
|----------------------|-----|--|
| 1. OGATA, Akari | JPN | |
| 2. HARRISON, Kayla | USA | |
| 3. WOLLERT, Heide | GER | |
| 3. AGUIAR, Mayra | BRA | |
| 5. VERKERK, Marhinde | NED | |
| 5. SATO, Ruika | JPN | |
| 5. MALZAHN, Luise | GER | |
| 5. VELENSEK, Anamari | SLO | |





IJF Grand Slam Tokyo 2011

(JPN Tokyo, 09-11 December 2011)

+78 kg

13 Judoka

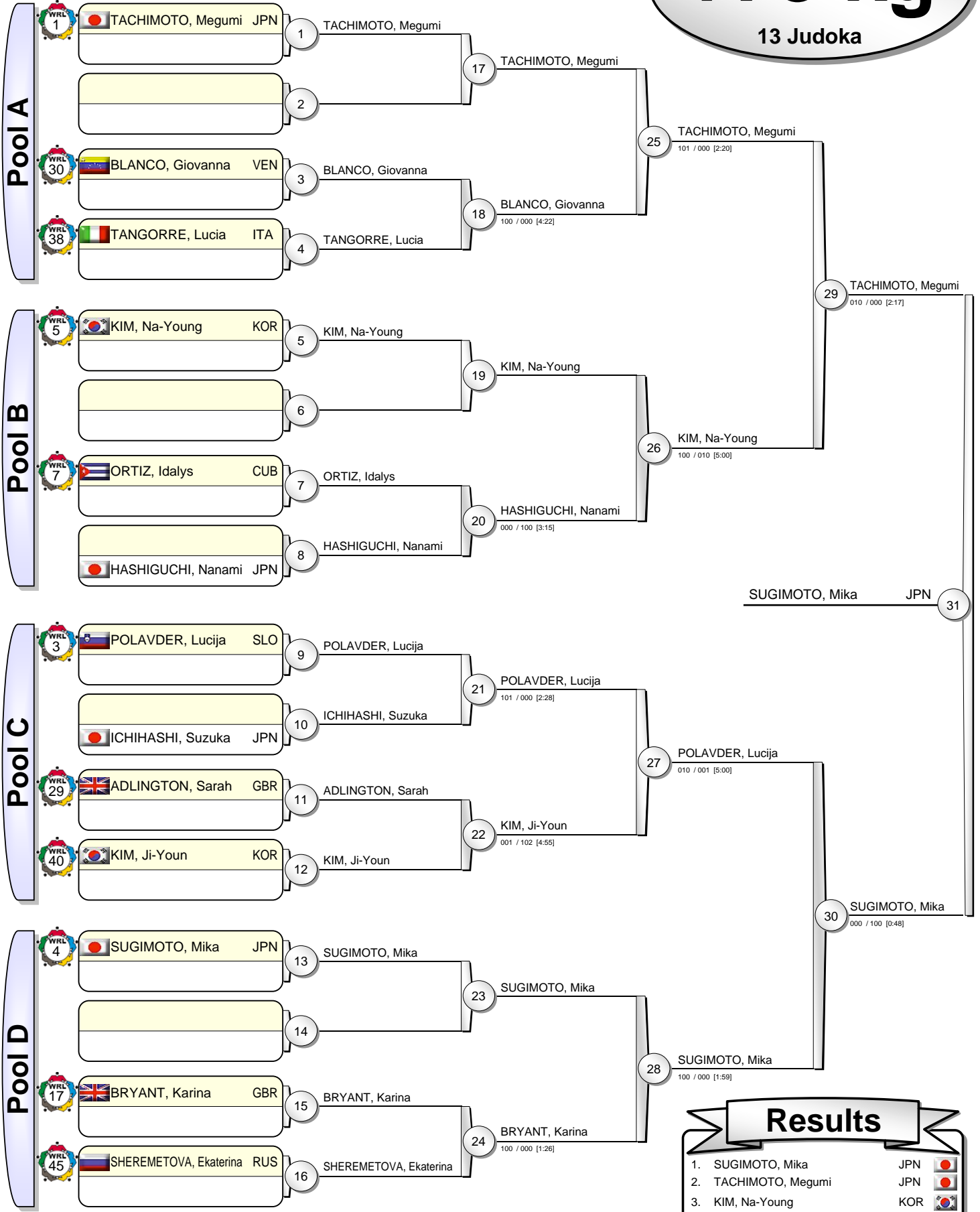

SUGIMOTO, Mika JPN 31

30 SUGIMOTO, Mika 000 / 100 [0:48]

Results

- SUGIMOTO, Mika JPN
- TACHIMOTO, Megumi JPN
- KIM, Na-Young KOR
- POLAVDER, Lucija SLO
- BLANCO, Giovanna VEN
- HASHIGUCHI, Nanami JPN
- KIM, Ji-Youn KOR
- BRYANT, Karina GBR





IJF Grand Slam Tokyo 2011: Medals

(JPN Tokyo, 09-11 December 2011)

| | | | | 1st place | 2nd place | 3rd place | 5th place | 7th place |
|-----|--|-----|--------------------------|-----------|-----------|-----------|-----------|-----------|
| 1. | | JPN | Japan | 11 | 5 | 10 | 9 | 0 |
| 2. | | RUS | Russia | 2 | 2 | 1 | 2 | 0 |
| 3. | | SLO | Slovenia | 1 | 0 | 1 | 2 | 0 |
| 4. | | KOR | Korea, South | 0 | 2 | 3 | 9 | 0 |
| 5. | | BRA | Brazil | 0 | 1 | 3 | 0 | 0 |
| 6. | | CUB | Cuba | 0 | 1 | 1 | 0 | 0 |
| 7. | | FRA | France | 0 | 1 | 0 | 5 | 0 |
| 8. | | ESP | Spain | 0 | 1 | 0 | 2 | 0 |
| 9. | | USA | United States of America | 0 | 1 | 0 | 0 | 0 |
| 10. | | GER | Germany | 0 | 0 | 2 | 4 | 0 |
| 11. | | BEL | Belgium | 0 | 0 | 2 | 0 | 0 |
| 12. | | NED | Netherlands | 0 | 0 | 1 | 3 | 0 |
| 13. | | MGL | Mongolia | 0 | 0 | 1 | 2 | 0 |
| 13. | | UZB | Uzbekistan | 0 | 0 | 1 | 2 | 0 |
| 15. | | GEO | Georgia | 0 | 0 | 1 | 0 | 0 |
| 15. | | POL | Poland | 0 | 0 | 1 | 0 | 0 |
| 17. | | ITA | Italy | 0 | 0 | 0 | 3 | 0 |
| 18. | | AZE | Azerbaijan | 0 | 0 | 0 | 2 | 0 |
| 18. | | GRE | Greece | 0 | 0 | 0 | 2 | 0 |
| 18. | | ISR | Israel | 0 | 0 | 0 | 2 | 0 |
| 18. | | KAZ | Kazakhstan | 0 | 0 | 0 | 2 | 0 |
| 22. | | CZE | Czech Republic | 0 | 0 | 0 | 1 | 0 |
| 22. | | GBR | Great Britain | 0 | 0 | 0 | 1 | 0 |
| 22. | | HUN | Hungary | 0 | 0 | 0 | 1 | 0 |
| 22. | | MDA | Moldova | 0 | 0 | 0 | 1 | 0 |
| 22. | | VEN | Venezuela | 0 | 0 | 0 | 1 | 0 |



IJF Grand Slam Tokyo 2011

(JPN Tokyo, 09-11 December 2011)

| | | | -48 | -52 | -57 | -63 | -70 | -78 | +78 | | -60 | -66 | -73 | -81 | -90 | -100 | +100 | | |
|-----|--|----------------------|-----|-----|-----|-----|-----|-----|-----|----|-----|-----|-----|-----|-----|------|------|----|----|
| 1. | | AND Andorra | | | | 1 | | | | 1 | | | | | | | 1 | 1 | 2 |
| 2. | | ARG Argentina | | | | | | | | 0 | | | | 1 | 2 | 1 | 1 | 5 | 5 |
| 3. | | ARM Armenia | 1 | | 1 | | | | | 2 | 1 | 1 | | | | | | 2 | 4 |
| 4. | | AUS Australia | | 1 | 1 | 1 | | | | 3 | 2 | 2 | | 1 | | | 1 | 6 | 9 |
| 5. | | AUT Austria | | | 1 | 1 | | | | 2 | 1 | 1 | 1 | | | | | 3 | 5 |
| 6. | | AZE Azerbaijan | | | 1 | 1 | | | | 2 | 2 | 1 | 1 | 1 | 1 | | | 6 | 8 |
| 7. | | BEL Belgium | 1 | 1 | | | | | | 2 | | 2 | 1 | | | 1 | | 4 | 6 |
| 8. | | BLR Belarus | | | | | | | | 0 | | | | 1 | | | 1 | 2 | 2 |
| 9. | | BRA Brazil | 1 | 1 | 1 | | | 1 | | 4 | 2 | | 1 | 2 | 2 | 2 | 2 | 11 | 15 |
| 10. | | CAN Canada | | | | | 1 | 2 | | 3 | 1 | 2 | 1 | 2 | 1 | | | 7 | 10 |
| 11. | | CHN China | | | | | | | | 0 | | | 1 | 1 | | | | 2 | 2 |
| 12. | | CMR Cameroon | | | | | | | | 0 | | | | | | 1 | | 1 | 1 |
| 13. | | CRO Croatia | | | | | | | | 0 | | | | 1 | | | | 1 | 1 |
| 14. | | CUB Cuba | | 1 | | 1 | | | 1 | 3 | | | | | 1 | | | 1 | 4 |
| 15. | | CYP Cyprus | | | | | | | | 0 | | 1 | | | | | | 1 | 1 |
| 16. | | CZE Czech Republic | | | | | | | | 0 | 1 | | 1 | 1 | | 2 | | 5 | 5 |
| 17. | | ECU Ecuador | | | 1 | | 1 | | | 2 | 1 | 1 | | | | | | 2 | 4 |
| 18. | | ESP Spain | 1 | 2 | 2 | 1 | 1 | | | 7 | | 1 | 1 | | | | | 2 | 9 |
| 19. | | EST Estonia | | | | | | | | 0 | | | 1 | | | | 1 | 2 | 2 |
| 20. | | FIJ Fiji | | | | | | | | 0 | | | | 1 | | | | 1 | 1 |
| 21. | | FIN Finland | | 1 | | | | | | 1 | 1 | | | | 1 | | | 2 | 3 |
| 22. | | FRA France | 1 | 2 | 2 | 1 | 1 | 1 | | 8 | 2 | 2 | 2 | 2 | 1 | 2 | | 11 | 19 |
| 23. | | GBR Great Britain | | | | | | | 2 | 2 | 1 | 1 | | 1 | | | | 3 | 5 |
| 24. | | GEO Georgia | | | | | | | | 0 | | | | | | 1 | | 1 | 1 |
| 25. | | GER Germany | | 2 | 2 | 2 | 2 | 2 | | 10 | 1 | | 1 | 2 | 1 | 2 | | 7 | 17 |
| 26. | | GHA Ghana | | | | | | | | 0 | | | 1 | | | | | 1 | 1 |
| 27. | | GRE Greece | | | 1 | | | | | 1 | | | | | 1 | | | 1 | 2 |
| 28. | | GUM Guam | | | | | | | | 0 | | | | | | | 1 | 1 | 1 |
| 29. | | HKG Hong Kong, China | | | | | | | | 0 | | | | 1 | 1 | | | 2 | 2 |
| 30. | | HUN Hungary | 1 | | | | | | | 1 | | | | 2 | | | | 2 | 3 |
| 31. | | IRL Ireland | 1 | | | | | | | 1 | | | | | | | | 0 | 1 |
| 32. | | ISR Israel | 1 | | | 2 | | | | 3 | 1 | 1 | 1 | | | 1 | 1 | 5 | 8 |
| 33. | | ITA Italy | 2 | 1 | | 1 | 1 | 1 | 1 | 7 | | 1 | 2 | 2 | 1 | | | 6 | 13 |
| 34. | | JPN Japan | 4 | 4 | 4 | 4 | 4 | 4 | 4 | 28 | 4 | 4 | 4 | 4 | 4 | 4 | 4 | 28 | 56 |
| 35. | | KAZ Kazakhstan | | | | | | | | 0 | 2 | 1 | 1 | 1 | 1 | 1 | 1 | 8 | 8 |
| 36. | | KOR Korea, South | 2 | 2 | 2 | 2 | 2 | 2 | 2 | 14 | 2 | 2 | 1 | 2 | 2 | 2 | 2 | 13 | 27 |
| 37. | | LUX Luxembourg | | 1 | | | | | | 1 | | | | | | | | 0 | 1 |
| 38. | | MDA Moldova | | | | | | | | 0 | | | 1 | 1 | | | | 2 | 2 |
| 39. | | MEX Mexico | | | | | | | | 0 | 1 | | | | | | | 1 | 1 |



IJF Grand Slam Tokyo 2011

(JPN Tokyo, 09-11 December 2011)

| | | | -48 | -52 | -57 | -63 | -70 | -78 | +78 | | -60 | -66 | -73 | -81 | -90 | -100 | +100 | | | |
|-----|--|-----|--------------------------|-----|-----|-----|-----|-----|-----|----|-----|-----|-----|-----|-----|------|------|----|-----|-----|
| 40. | | MGL | Mongolia | 1 | 1 | 1 | 1 | 1 | 1 | 6 | 2 | 2 | 2 | 1 | | 2 | 1 | 10 | 16 | |
| 41. | | MON | Monaco | | | | | | | 0 | 1 | | | | | | | 1 | 1 | |
| 42. | | MOZ | Mozambique | | | | | | | 0 | | 1 | 1 | | | | | 2 | 2 | |
| 43. | | NED | Netherlands | 1 | | 1 | 2 | 1 | 1 | 6 | 1 | | 1 | | | 1 | 2 | 5 | 11 | |
| 44. | | NEP | Nepal | | 1 | | | | | 1 | | 1 | | | | | | 1 | 2 | |
| 45. | | PAK | Pakistan | | | | | | | 0 | | 1 | | | | 1 | | 2 | 2 | |
| 46. | | PLW | Palau | | | | | 1 | | 1 | | | | | | | | 0 | 1 | |
| 47. | | POL | Poland | | 1 | | 1 | 1 | | 3 | 1 | 2 | 2 | 1 | 1 | | 1 | 8 | 11 | |
| 48. | | POR | Portugal | | | | | | | 0 | | | | 1 | | | | 1 | 1 | |
| 49. | | ROU | Romania | | 1 | | | | | 1 | | 1 | | | | 1 | | 2 | 3 | |
| 50. | | RSA | South Africa | | | | | | | 0 | | | 1 | 1 | 1 | | | 3 | 3 | |
| 51. | | RUS | Russia | 2 | 2 | 1 | 2 | 1 | 1 | 9 | 2 | 2 | 2 | 2 | 2 | 1 | 2 | 13 | 22 | |
| 52. | | SEN | Senegal | | | | | | | 0 | | | | 1 | | | | 1 | 1 | |
| 53. | | SLO | Slovenia | | 1 | | 2 | | 1 | 5 | | 1 | | 1 | | 1 | | 3 | 8 | |
| 54. | | SUI | Switzerland | | | | | 1 | | 1 | 1 | | 1 | | 1 | | | 3 | 4 | |
| 55. | | SVK | Slovakia | | | | | | | 0 | | | | | 1 | | | 1 | 1 | |
| 56. | | SWE | Sweden | | | 1 | | | | 1 | | | | | 1 | 1 | | 2 | 3 | |
| 57. | | TJK | Tajikistan | | | | | | | 0 | | | | 1 | | 1 | | 2 | 2 | |
| 58. | | TPE | Chinese Taipei | | | 2 | 1 | | | 3 | 1 | | | 2 | 1 | 1 | | 5 | 8 | |
| 59. | | UKR | Ukraine | | | | | | | 0 | 2 | 1 | 2 | 1 | 2 | 2 | | 10 | 10 | |
| 60. | | USA | United States of America | 1 | | 1 | 1 | | 1 | 4 | 1 | | 1 | | | 1 | | 3 | 7 | |
| 61. | | UZB | Uzbekistan | | | | | | | 0 | 1 | 1 | 2 | 1 | 1 | 1 | 1 | 8 | 8 | |
| 62. | | VEN | Venezuela | | | | 1 | | 1 | 2 | | 1 | 1 | | | | | 2 | 4 | |
| | | | | 21 | 26 | 26 | 29 | 19 | 17 | 13 | 151 | 39 | 38 | 39 | 43 | 31 | 32 | 25 | 247 | 398 |